

**RCT2PC
MANUAL FRONT COVER**



ROLLER COASTER HISTORY

It's difficult to trace the origins of the thrill ride — for all we know, Stonehenge is just the ruined supports for an early roller coaster. But we do know one thing: that mind-clearing adrenaline buzz you only get from being scared out of your wits is a timeless human endeavor.

The Ice Age

Most coaster historians consider Russian ice slides the forerunners of roller coasters. These large wooden structures, up to 70-feet tall, were popular throughout Russia in the 16th and 17th centuries. Riders would use a wooden sled or block of ice to slide at up to 50 miles-per-hour (mph) down giant ice-covered wooden hills and crash-land into a sand pile at the bottom.

Somewhere along the line, a French businessman brought the ice slide idea back to France, perhaps forgetting that Russian-like winters might be a prerequisite for their success. Undeterred, he or someone else developed an all-season solution by waxing the sled runners. Eventually, someone swapped wheels for runners, and more ambitious and thrilling tracks were created. In 1817 someone attached the carts to the tracks and dubbed the ride the Russian Mountains of Belleville. It had two tracks that ran next to each other, so riders could race (and onlookers could bet on the outcome).

Runaway Train

The ultimate American thrill ride — past or present — may well have been the Mauch Chunk Switchback Gravity Railroad, in Mauch Chunk, Penn. (now called Jim Thorpe, Penn.). It was the second railroad ever built (1827) in the United States, and was originally used to haul coal from mountaintop mines down to the Lehigh River. The track was built so that miners could load mine cars with coal, shove them over the hillside, and let gravity do the rest.

Mules, whose job was to pull the cars back up the hill, and a brave, solitary brakeman were apparently the first participants in this nine-mile, hair-raising tear down the mountain. Thrill-seekers soon took notice, and the track was converted to a thrill ride in the afternoons. Eventually, the mules were replaced by a steam engine that hauled the empty cars up a longer, more gradual track.

People would pay \$1 to ride up the gradual incline, then the steam engine was removed, and the cars were pushed back down the hill, with speeds apparently reaching nearly 100 mph. Now that's a roller coaster!

In 1872, a new tunnel was constructed, which made the track obsolete for



coal-hauling. Eventually a restaurant and hotel were built at the top, and the ride attracted more than 35,000 passengers a year. It continued to operate, with an amazing safety record, until it was closed in 1933.

Upside Down Side

Way back in 1846, an Englishman apparently sold a loop-the-loop coaster ride to the French. This Paris attraction, called the Centrifuge Railway (Chemin du Centrifuge), featured a 43-foot high hill leading into a 13-foot wide loop. The rider would sit in a wheeled cart, pray to the physics gods, and hang on as the car whipped down the hill and through the loop with only centrifugal force keeping the cart and rider on course.

Nearly 50 years later, in 1895, Lina Beecher revived the idea with the Flip-Flap Railway, a 25-foot circular loop at Coney Island. The circular design was very unforgiving in the g-force department, and whiplash complaints were no doubt part of the reason why it only lasted a few seasons. In 1901 a man named Edward Prescott built a new looping coaster, also at Coney Island. This ride, called Loop The Loop, was oval-shaped to reduce g forces. Its low seating-capacity, perhaps, was why it only lasted six years.

Getting Real

The first "roller coaster tycoon" was probably La Marcus Thompson, the man who created the Gravity Pleasure Switchback Railway, which opened at Coney Island in 1884. His ride was a 650-foot long wooden structure shaped like the Russian ice slides. Riders would climb a platform, board cars and be pushed down a hill and over a few bumps. At the other end, workers would hoist the car to the top of a second station, riders would board again and coast back in the other direction. The early ride focused more on sightseeing than excitement, so the bench-like coaster cars faced sideways and the ride traveled at a mere 6 mph. But people loved it: Thompson charged just a nickel a ride, and made more than \$600 a week.

Thompson's success was an inspiration. In late 1884, a man named Charles Alcock created a U-shape version of the Switchback ride that did not require riders to unload and reload mid-way. In 1885 Phillip Hinkle added a cable hoisting mechanism. Soon, track-mounted brakes were developed, track designs improved, and the rides began to look and act like modern-day roller coasters.

In 1912, coaster designer John Miller, who got his start as LaMarcus Thompson's chief engineer, patented a design for the under-friction roller coaster. This revolutionary safety advancement made steeper drops and faster



speeds possible by holding the cars to the tracks and reducing drag. Miller, a complete coaster tycoon, held over 100 patents on roller coaster devices, and designed more than 100 roller coasters.

Miller's safety advances apparently inspired inventors to push design limits even further. Take the infamous Cyclone of Crystal Beach, Ontario, Canada. This ride, designed by Harry Traver in 1927, topped out in the intensity department — often leaving riders with broken ribs or snapped collar bones. (An on-staff nurse was always present.) It failed to profit and was eventually shut down, apparently because more people came to watch others ride it rather than “enjoy” the ride themselves.

The Cyclone was not the only roller coaster from this era that didn't last. The Great Depression and World War II saw the decay and destruction of more than 1,500 roller coasters in the United States, and at least that many overseas.

Back on Track

The amusement park industry was given a shot in the arm in 1955 with the opening of the first successful theme park: Disneyland. Disney's contribution to coaster history was Matterhorn Mountain, the first tubular steel coaster.

Steel construction allowed for much faster and more thrilling rides, including the Corkscrew at Knott's Berry Farm (Buena Park, Calif.), in 1975, and Magic Mountain California's Great Revolution, built in 1976. Both rides revived the centuries-old novelty of going upside down (this time with proper safety restraints). These led to rides with double loops, triple loops, and combinations of corkscrews, loops and other elements — the race was on!

Since then we've seen inverted coasters (cars travel beneath the tracks), linear induction motor coasters (power-launched), “giga-coasters,” (over 300 feet tall), multi-dimensional coasters (free-spinning cars), vertical coasters, air-powered coasters, and more. No one knows what the future will bring, but it's safe to predict that — whatever it is — it will be faster, taller, longer, scarier, and, best of all, more fun.



TABLE OF CONTENTS

FIRST THINGS FIRST 6	RIDE CONSTRUCTION 34
The ReadMe File 6	Building a Ride 36
System Requirements 6	Ride Construction Window 37
SETUP AND INSTALLATION 7	Caring for Your New Ride 38
WELCOME! 8	RUNNING A PARK 41
WHAT'S NEW 8	Staff 41
KEYBOARD SHORTCUTS 9	Managing Rides and Facilities 44
SAVING AND LOADING 10	Caring for Guests 45
MAIN MENU 11	Finances 48
ON BEING A TYCOON 14	CREATING A COASTER 52
Common Window Elements 14	Roller Coaster Designer 52
MAIN VIEW SCREEN 15	Coaster Checklist 53
Pause / Options 15	Simple Sample 54
View Control Tools 17	Managing Your Track Designs 56
Construction Tools 19	DESIGNING A SCENARIO 57
Management Tools 20	Tips on Using the Scenario Editor . . . 57
Finances and Park Rating 20	Scenario Editor Elements 58
Date / Weather / Messages 21	Convert Saved Game to Scenario . . . 63
BUILDING A PARK 22	INFOGRAMES WEB SITES 64
Park Information 22	TECHNICAL SUPPORT 64
Excavating 24	LICENSE AGREEMENT 67
Scenery 27	CREDITS 71
Footpaths and Queue Lines 31	



FIRST THINGS FIRST

The Readme File

The RollerCoaster Tycoon® 2 CD-ROM game has a ReadMe file where you can view both the License Agreement and updated information about the game. We strongly encourage you to take the time to read this file in order to get the benefit of changes made after this manual went to print.

To read this file, double-click on the ReadMe.txt icon in the RollerCoaster Tycoon 2 directory found on your hard drive (usually C:\Program Files\Infogrames Interactive\RollerCoaster Tycoon 2). You can also view the ReadMe file by clicking on the Start button on your Windows® 98/Me/2000/XP taskbar, then selecting Programs, then Infogrames Interactive, then RollerCoaster Tycoon 2, and then the ReadMe file.

System Requirements

Operating System:	Windows® 98/Me/2000/XP
Processor:	Pentium® II 300 MHz or equivalent
Memory:	64 MB RAM (128 MB recommended)
Hard Disk Space:	120 MB free (200 MB recommended)
CD-ROM Drive:	4X or higher (8X recommended)
Video:	Windows® 98/Me/2000/XP-compatible video card*
Sound:	Windows® 98/Me/2000/XP-compatible sound card*
DirectX®:	DirectX® version 8.1 (included) or higher

*Indicates device should be compatible with DirectX® version 8.1 (included) or higher.



SETUP AND INSTALLATION

1. Start Windows® 98/Me/2000/XP. Exit all other programs before installing.
2. Insert the RollerCoaster Tycoon 2 CD-ROM game disc into your CD-ROM drive.
3. If AutoPlay is enabled, a title screen should appear. Click on the Install button. If AutoPlay is not enabled, double-click on the "My Computer" icon on your Windows® desktop. Next, double-click on your CD-ROM icon. If the install screen still does not appear at this point, double-click on the "My Computer" icon, then double-click on your CD-ROM icon, then double-click on the Setup icon.
4. Follow the on-screen instructions to finish installing the RollerCoaster Tycoon 2 CD-ROM game.
5. Once installation is complete, double-click on the RollerCoaster Tycoon 2 game icon to start the game.

Note: Minimum install copies all of the files required to play the game, but leaves some of the larger files on the CD. This option lets you conserve hard disk space. **Full install** copies more files to your hard disk. The main difference you may notice between Minimum and Full install is that with Full install you can play two musical themes at once if two rides close to each other both have music. Both Minimum and Full install require that the game disc be in your CD-ROM drive in order to play the game.

Installation of DirectX®

The RollerCoaster Tycoon 2 CD-ROM requires DirectX® 8.1 or higher in order to run. If you do not have DirectX® 8.1 or higher installed on your computer, click "Yes" when asked if you would like to install it.



WELCOME!

The world's most addictive game ramps up the FUN with America's favorite theme parks — Six Flags®! Break ground and start from scratch, open the gates to existing parks or just create the most gut-wrenching roller coaster ride ever — it's up to you! With wild new rides, new theme decorations and easy-to-use building tools, creating the ultimate amusement park is now more fun than ever!

WHAT'S NEW?

If you've played the original *RollerCoaster Tycoon* CD-ROM game, you can probably jump right in at the scenarios and start to discover the new features and enhancements for yourself. We recommend you play through the tutorial levels, however, to learn about some of the new enhancements.

Part of the fun of a new game is exploring and discovering. With that in mind, this manual won't give away everything about *RollerCoaster Tycoon 2*, but rather introduce the major features and describe when and where they appear. We'll leave the details for you to discover.

The most obvious change is how easy it is to PLAY YOUR WAY in *RollerCoaster Tycoon 2*. The following are the most obvious examples of this new freedom, available right from the Main Menu:

- **5 New Scenario Categories** – Play scenarios in any order!
- **Roller Coaster Designer** – Design the ultimate ride without distraction! (See page 52.)
- **Scenario Editor** – Create your own games to share with friends! (See page 57.)

Compatibility

RollerCoaster Tycoon 2 is all new. Under the hood of the game is new, more efficient program code and many new features. Because of this, saved games from previous versions of the game — *RollerCoaster Tycoon*, *Corkscrew Follies*, and *Loopy Landscapes* — are NOT compatible.

You can import landscapes from older saved games into your scenarios while in the Scenario Editor (see page 57). Most landscape files from previous versions of *Roller Coaster Tycoon* will load, but some scenery items might look different. It is possible that unpredictable results might arise from importing landscapes from these products. Technical Support cannot help you with these types of issues.



KEYBOARD SHORTCUTS

Though it's possible to control the game using only the mouse, there are a number of keyboard shortcuts that can speed things up. The following are the default key commands. You can reassign any command in the **Options** menu, while playing the game.

Command	Key
Close topmost window	Backspace
Close all floating windows	Shift + Backspace
Cancel construction mode	Esc
Pause game	Pause
Zoom out	Page Up
Zoom in	Page Down
Rotate View	Enter
Rotate construction object	Z
Underground view toggle	1
Remove base land toggle	H
Remove vertical land toggle	V
See-through ride	3
See-through scenery	4
Invisible supports	5
Invisible guests	6
Height marks on land	8
Height marks on ride tracks	9
Height marks on paths	0
Adjust land	F1
Adjust water	F2
Build scenery	F3
Build paths	F4
Build new ride	F5
Financial information	F
Research information	D
Rides / Attractions list	R
Park information	P
Guest list	G
Staff list	S
Recent messages	M
Show map	Tab
Screenshot	Ctrl + S

Real Roller Coaster Déjà Vu



RCT2 Coaster Type: Inverted Vertical Shuttle

Specs: 196 feet tall; 1,203 feet long; 65 mph max

Special Features: Riders dangle face-down up the first tower, then drop 178 feet straight down, through a 102-foot vertical loop, 110-foot butterfly and up the second 178-foot tower. Then they ride it again — backwards!

Location: Six Flags Magic Mountain — Los Angeles; Six Flags Over Georgia — Atlanta; Six Flags Great America — Chicago

**Look for this ride in the Six Flags Magic Mountain scenario.*





SAVING AND LOADING

The commands for saving and loading game files, track designs, landscapes and scenarios vary slightly depending on where you are in the game, but it is self-explanatory once you understand the interface.

TIP

It's a good idea to save your game before you spend a bunch of money creating a new custom ride or an ambitious landscaping project. Saving your park at the beginning of each year is also helpful.

You can save your progress in a RollerCoaster Tycoon 2 game at any time by clicking on the **Options** button (diskette icon) in the **Main View**, and selecting Save.

Similarly, clicking on the **Options** button (diskette icon) while in the Scenario Editor will save the landscape you are currently tinkering with. To save a scenario, click the double-arrow button in the lower right corner that takes you through the steps of creating a scenario. The final step saves the scenario.

To save a track design, click the **Save** button (diskette icon) in the **Ride Statistics** tab of any **Ride** window. (See page 40 for more details.) **Note:** The **Save** button only appears after you have successfully tested the ride.

Each track that you save is automatically put in the Tracks folder on your hard drive. You can find the Tracks folder in the location where RollerCoaster Tycoon 2 was installed (usually C:\Program Files\Infogrames Interactive\RollerCoaster Tycoon 2\Tracks). If you manually place a track design file in the Tracks folder, it will automatically show up in your **New Rides** window in the proper category.

To install a new track from within the game that is not in the Tracks folder, click on the **Install New Track Design** button while you are in the Track Designs Manager. (See page 56.)

To load a game while playing, or a landscape while creating a scenario, click the **Options** button in the **Main View**. To load a game from the **Main Menu**, click the **Load** button.



MAIN MENU

Start a New Game **Load a Saved Game**

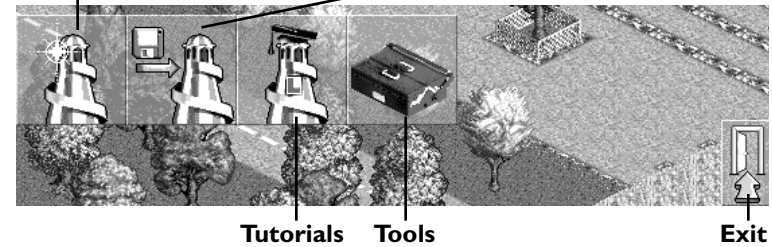

Start A New Game

This is where your fun begins! Click on the **Start New Game** button and you're on your way — but you're not inside the park yet. RollerCoaster Tycoon 2 includes a number of park scenarios. What you see is the **Scenario Selection** window.

The scenarios are divided into five categories, indicated by tabs. Click on a tab to see the scenarios listed under that category. When you move the mouse cursor over a scenario name, information about that scenario is displayed on the right side of the window, including a summary, objectives, and the name and rating of any player who has completed it before.

Choose a scenario and click on the name to play it. Click on the **Close Window** button [X] in the upper right corner of the window to go back to the Main Menu without choosing a scenario. When you have completed a scenario, your success and your score are noted in the **Scenario Selection** window. Scenarios are divided into the following categories:

Beginner Parks – These “entry-level” scenarios will help you get a feel for how the game works, and introduce you to the tools and techniques you'll need to become a full-fledged tycoon.

Challenging Parks – These scenarios are the next step in your quest to be a tycoon, and will introduce you to further fine-points of park management.

Expert Parks – Want a real challenge? Expert Parks pull out all the stops. If you successfully make it through these thorny trials, you can confidently call yourself a tycoon!



“Real” Parks – These parks were designed from actual real-life parks from around the world. If you have visited any, see if you can find your way around them and, most importantly, keep them running and out of the red.

Other Parks – These scenarios include special parks that fall outside the above definitions.

Note: When you create a scenario, you can assign it to any of the above categories. It will then show up with the other scenarios listed when you start a new game. (see page 63.)

Load / Continue

Click here if you want to pick up where you left off in a saved game.

Tutorial

If you want to learn the basics of building and running your own park, or need

TIP

You don't have to just sit and watch the tutorials. While a tutorial is running, you can click on any mouse button or press any key to take over control. The only caveat is that you can't give control back to the tutorial once you interrupt it. To restart the tutorial you must go back to the **Main Menu** and run it again.

a quick refresher, we recommend you click on **Tutorials** first. Tutorials are animated scenarios that feature step-by-step instructions and advice. Clicking on the **Tutorials** button displays a drop-down menu with the following choices:

Beginners – If you have never played RollerCoaster Tycoon or RollerCoaster Tycoon 2 before, we recommend starting here. If you played the original game but want a refresher course, this should be your first stop.

Custom Rides – Includes tips on making rides and a sneak peek at some new features. Start here if you have played RollerCoaster Tycoon before and

feel confident in your park-building abilities.

Roller Coaster Building – Whether you're an old pro or a newcomer, you can always learn something from the Roller Coaster Building tutorial.

Tools

Clicking on the **Tools** button opens the **Tools** menu, where you'll find the following:

Scenario Editor – This fantastic new feature lets you design and create your own scenarios, which you can share with other players. You decide the look and layout of the park, and even set the scenario's objective! (See page 57 for more details.)



Convert Saved Game to Scenario

– This lets you load a saved game, create new objectives for it, and save it as a scenario. If you have already started a game, you can use this tool to create a scenario that includes a park already in full swing, or an aged park in need of help. (See page 63 for more details.)

Roller Coaster Designer – This tool lets you design a ride in peace with no scenario objectives, money constraints, or guests to distract you. Build rides, test them and fine tune them until they are perfect, and then save the track design to share with other players or use in one of your own parks. (See page 52 for more details.)

Track Design Manager – After you have designed or downloaded several new rides, this tool will help you keep them organized. (See page 56 for more details.)

Exit

Click here when you are done playing RollerCoaster Tycoon 2.

Real Roller Coaster Medusa



RCT2 Coaster Type: Floorless

Stats: 142 feet tall; 3,985 feet long; 61 mph max speed

Special Features: Riders sit on open-air pedestal-like seats — with legs dangling — through 7 inversions, including 114-foot vertical loop, 96-foot dive loop, heartline cambelback (zero-gravity roll), cobra roll, and two interlocking corkscrews.

Locations: Six Flags Great Adventure – New Jersey; Six Flags Marine World – San Francisco

**Look for this ride in the Six Flags Great Adventure scenario.*





ON BEING A TYCOON

Even when you're destined for greatness, you've got to take things one step at a time. If you are going to succeed at the challenging task of building and managing your own amusement park, you must mind the details.

The opportunities for failure are numerous. You can let your park fall into disrepair, overcharge or over-nauseate your guests, or overdraw your bank account. Guests can get lost, hungry, bored, disgusted and depressed. Rides can break down, break apart and go out of style. Flowers can die, research can dwindle and your marketing plans can go awry.

Your first step is to learn the interface. The interface elements are similar, whether you're playing Tutorials, Scenarios, Roller Coaster Designer or Scenario Editor. Some buttons and tabs open up new windows and reveal more information and features. These windows are explained in detail later in this manual.

Common Window Elements

Most windows share these common interface elements:

A. Tabs – Many windows contain a row of tabs, which organize the statistics, feedback and options you will need to access while playing the game. Click on a tab to display the information it contains.

B. Drop-Down Menus – Some buttons are linked to drop-down menus. Click and hold to display the menu, then move your mouse cursor over the menu item you wish to select and release the mouse button to select it. Some menus, such as the **Open / Test / Close Ride**

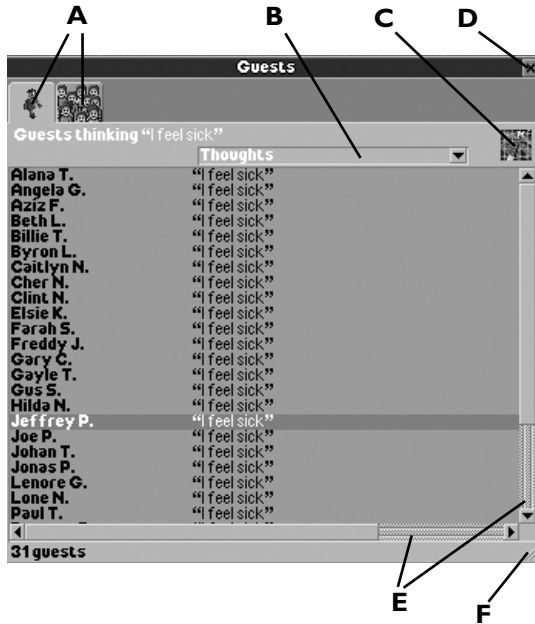

menu, will select the next item in the list if you simply click on it.

C. Buttons – Buttons activate a specific game element.

D. Close – Click the [X] button to close a window.

E. Scroll Bar – Some windows contain scroll bars that let you access hidden information. Click on a scroll bar to scroll through your options.

F. Resize – Click and drag the bottom right corner of a window to expand or contract its size.

MAIN VIEW SCREEN

The **Main View** contains your park in the background, tool buttons along the top, and information buttons in the lower left and right corners. Click on any button to open its associated window.

Pause / Options

Pause

This button stops time until you click it again. All activity stops in the park and you cannot build while the game is paused. You can do other tasks, however, including looking at statistics, dealing with finances, managing staff, redecorating rides and eavesdropping on your guests' thoughts.

Options

The **Game Options** menu contains the following:

Real Roller Coaster Chang



RCT2 Coaster Type: Stand-up Twister Coaster
Coaster Specs: 154 feet high; 4,155 feet long; 63 mph max

Special Features: World's longest, fastest, tallest stand-up coaster contains world's biggest vertical loop (121.6 feet), plus 104-foot dive loop, 72-foot inclined loop, and 2 corkscrews.

Location: Six Flags Kentucky Kingdom – Louisville

*Coaster type only featured in game — not actual ride.





Load Game – Click here to open a saved game and resume playing it.

Save Game – Save your current game so that you can load it later.

About RollerCoaster Tycoon 2 – Click here to view the list of folks who helped make this game possible.

Options – Opens the **Options** window, which includes a number of game settings you can change to customize the way RollerCoaster Tycoon 2 works.

Sound – This drop-down menu lets you pick the sound card driver the game will use.

Music – Toggle music ON or OFF.

Sound Quality – Choose between LOW, MEDIUM and HIGH.

Forced Software Buffer Mixing – This setting should automatically be adjusted when you install the game.

However, if the game stalls regularly or the sound crackles, then toggling this setting ON or OFF might improve those problems.

Currency – This drop-down menu lets you set the type of currency used in your park.

Distance and Speed – Choose between Imperial and Metric systems of measurement.

Temperature – Choose between Fahrenheit and Celsius.

Height Labels – Choose between Real Values (5 feet or 1.5 meters per elevation block) or Units (one unit per elevation block).

Display Mode – Choose among various screen resolutions. Higher-resolution settings might slow the game down.

Note: Although the game features a variety of screen modes, it is designed to provide optimum performance in 800x600 mode.

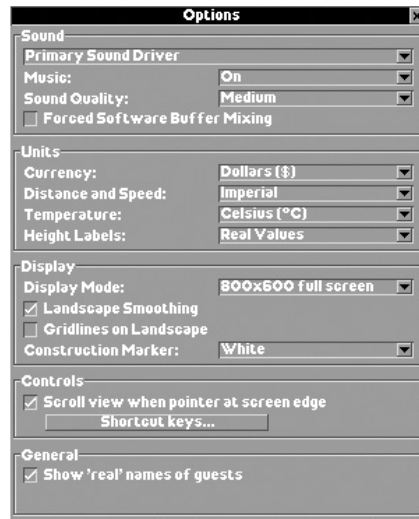

Landscape Smoothing – Toggle ON to smooth angled edges on landscape.

Gridlines on Landscape – Turn landscape gridlines ON or OFF.

Construction Marker – Set construction markers to White or Translucent.

Scroll View – When ON, the **Main View** will scroll when you move the mouse cursor to the edge of the screen.

Shortcut Keys – Click here to see a list of keyboard shortcuts. Click on a command in the list to assign a new shortcut to it. (See page 9 for a list of default keyboard shortcuts.)

Show Real Names of Guests – When ON, guests are assigned real names; when OFF they are assigned numbers, such as “Guest 234.” (See page 46 for information on how to change a guest’s name.)

Screenshot – Takes a snapshot of the current screen and saves it in a file in the directory where you installed RollerCoaster Tycoon 2. The default keyboard shortcut for this command is **Ctrl + S**.

Quit Game – Ends your current game (you have the option to save it) and exits to the **Main Menu**.

View Control Tools

 **Zoom Out** Enlarges the amount of the park you see in the **Main View**, but displays less detail.

 **Zoom In** Takes a step closer to the action — displays a smaller area of the park in more detail.

 **Rotate View** Rotates the landscape a quarter turn (90 degrees) clockwise.



View Options

Sometimes — when you're building structures, for example — you need an uncluttered view. The **View Options** menu includes several ways to achieve this. Select an item from the menu to toggle it ON or OFF. A check mark next to a menu item indicates that option is ON. You can have any combination of view options — or even all of them — activated at the same time.

Underground / Inside View – Makes the land surface transparent and provides an underground view. Use this when building underground. The game automatically switches to the underground view when a path or ride you are building goes below the surface.

Remove Base Land – Completely removes the land graphics, allowing you to see underground rides and scenery more easily.

Remove Vertical Faces – Completely removes the vertical “cliff faces” on landscapes.

See-Through Rides – All of your attractions (including shops and stalls) become invisible.

See-Through Scenery – The scenery (trees, bushes, walls, and so on) becomes invisible.

Invisible Supports – The structural supports of your rides become invisible, offering a clearer view of the areas beneath them.

Invisible People – All guests and staff are removed from sight. This is quite helpful when your visitors are roaming your park like swarms of bees, obscuring everything.

Height Marks – There are three options for displaying height marks: on Land, on Ride Tracks, and on Paths. This marks every square of land, path or ride track with its height level relative to the elevation of your park gates. This is handy when you're trying to match up sections of footpaths or track, and for making the most efficient use of your landscape.

Note: You can choose whether height marks are displayed as Real Values or Units in the **Options** menu (see page 16).



Mini-Map

Click on this button to open the **Mini-Map** window, which is a map of the entire park area with tiny representations of paths, rides and guests. Land owned by the park is colored a lighter shade. Click anywhere on this map to center the **Main View** there.

There are two tabs in the **Mini-Map** window: **Guests** and **Objects**. Use the **Guests** tab to help identify overcrowding and clogged paths. Use the color-coded legend on the **Objects** tab to locate rides and shops. This can help you disperse needed refreshment stands, for example.

Construction Tools

Bulldoze

You can always use the right mouse button to bulldoze trees, scenery and paths one item at a time while in any construction mode. But, you can use this handy tool to demolish larger areas of scenery with a single click. (See page 24.)

Land Tools

Think of the **Land** tool as your paint and paintbrushes. When you go out to craft and tame the land in your park, the tools will help you. Use the **Land** tool to adjust the height and slope of any landscape tile (square) in the park. (See page 24.)

Water Tools

If you lead a guest to water, you can probably get him to cool down on a water ride! Use the **Water** tool to create lakes, rivers and ponds. (See page 24.)

Scenery / Theme Objects

Scenery objects include gardens, statuary, benches, shrubs, and other useful or decorative non-ride items in your park. Click here to place them in your park. (See page 27.)

Build Footpaths / Queue Lines

You'll use this button often, as you fill your park with (and tear up) walking paths, queuing lines, ramps and bridges. (See page 31.)

Build New Ride / Attraction

Click on this to open the **Ride Creation** window. This is where the fun really begins (and the cash starts to flow). (See page 34.)



Management Tools



Rides / Attractions in Park

To really excel as a “roller coaster tycoon,” you must analyze park data and adapt to changes, so your guests remain happy, and eager to spend time and money in your park. The **Rides / Attractions** window presents a number of useful overall reports on every ride and facility in the park. (See page 38.)



Park Information

This button does the same thing as clicking on the **Park Entrance**: it opens the **Park Status** window. (See page 22.)



Staff

This opens the **Staff** window, where you can hire, control and fire park employees. (See page 41.)



Guests

You were born to be a tycoon, and the visitors who come to your parks thank you! Click here to learn more about the little people you love to entertain. (See page 45.)

Finances and Park Rating



A. Finances

This information button shows your current cash on hand. When you move your mouse cursor over this figure, your current weekly profit and park value are displayed in a pop-up window. Clicking on the number opens the **Financial Summary** window (see page 48). You can change the monetary unit in the **Options** menu.

B. Guest Population

This is the number of people currently in your park. Click on this number to open the **Guest** tab in the **Park Information** window.



C. Park Rating

The longer the green line, the higher your park rating. When you move your mouse cursor over the green line, your actual park rating (between 0 and 1,000) is displayed in a pop-up window. Click on the green bar to open the **Park Rating** tab in the **Park Information** window.

Date / Weather / Messages



Date

Some scenario objectives are time-based — be sure to keep an eye on the calendar so you don’t miss a deadline. The window displays the current month and year, and moving your mouse cursor over the date will display the day in a pop-up window.

Note: Years are measured from March to October, since parks typically operate seasonally.

Weather

Take a look here to see the current temperature and weather conditions. You can change the temperature units (Celsius or Fahrenheit) in the **Options** menu.

Recent Messages

Click anywhere on the **Date / Weather** button to display the **Recent Messages** window, which lists recent on-screen announcements, such as ride breakdowns, new research discoveries and awards.

TIP

When it rains, all of your guests will want umbrellas, and the only place they can get them is at your Information Kiosks and Souvenir Stands. Make sure you’re not undercharging for them.



BUILDING A PARK

Park Information

The **Park Information** window is the first window that opens when you start a new game. (You can open the **Park Information** window at any time by clicking on your park gate, the boundaries of your park, or the **Park Information** button on the top of the screen.) You'll probably want to build a few attractions and facilities before you open your gates to guests, but when you eventually officially open your park, this is the place to do it.

This is also where you can set your admission price (unless you are playing a scenario with no gate admission). You will probably return here to adjust the admission price as you add attractions.

The **Park Information** window is also where you can buy or lease more land for your park.

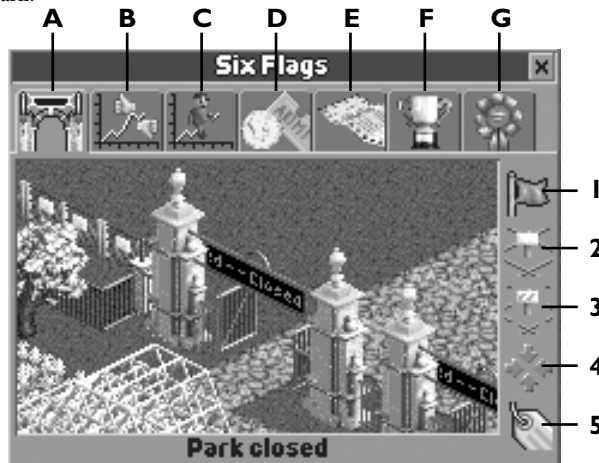

A. View Park Entrance – Take a look at the entrance to your park. (This is a handy spot to drop off those lost guests you may bump into now and again.) This window has five buttons on the right side, indicated by numbers in the screen shown above.

1. Open / Close – Click here to open your park for business. Click again to close it.



2. Buy Land – Sometimes you just don't have enough room to spread your wings. When you run out of space to place your attractions, click on this button to see land near your park that is for sale. Each square of land for sale shows up on the landscape with a little white sign on it. (Land that you own shows up as a fenced-in blue grid.) Click on a square of land to buy it.

3. Buy Construction Rights – Sometimes a landowner can't or won't sell, but doesn't mind letting you hang a corner of a coaster over his property. This option lets you purchase the right to build all or part of an attraction on a parcel of land. When you click on this button, every square of land with construction rights for sale shows up with a blue-striped sign on it. Click on a square of land to buy construction rights to it.

4. Snap To / Locate – Click on this button to center the park gate in the **Main View**.

5. Rename – Click here to rename your park.

B. Park Rating – Some scenarios require that your park achieve a certain rating — a sort of overall tycoon score. This tab shows your current park rating and a graph of that rating over time.

C. Guests – Click on this tab to see how many guests are currently visiting your wonderful park, as well as a graph of your park population over time.

D. Admission – Click on this tab to set the ticket price for your park. (The minimum admission price is free, the maximum is \$100.) It also displays the number of admissions to your park to date, as well as total income from admissions.

E. Park Statistics – This displays global data on different aspects of your park, including overall size, number of rides, staff and number of guests in the park.

F. Objectives – Click on this tab to view the goal of the current scenario.

G. Awards – From time to time you might win a special award — it might be quite wonderful, or it might be a badge of shame! Click on this tab to view your park's awards.

TIP

Keep an eye on your guests' thoughts. If lots of them are thinking about what a great value your park is, maybe you should raise the admission price.



Excavating

Reshaping the land to accommodate the roller coasters, trains, paths, tunnels, gardens, water rides and theme areas comes with the territory, so to speak. To run the most successful parks, you're going to have to push some dirt.

Clear Scenery

The **Clear Scenery** tool allows you to easily remove areas of trees and walls larger than a single square in size. The **Clear Scenery** tool works much like the **Land** tool (see "Land and Water Windows" below).



First, click the **Bulldoze** button to open a window where you can choose the size of the "brush" you will use to alter the landscape, then click on the landscape to clear all trees, walls, and small scenery items. **Note:** This will not demolish large

multi-block scenery, rides, footpaths or signs. The estimated cost is shown below the grid-size graphic on the window.

Important: Remember that the **Clear Scenery** tool is not the only way to remove scenery. You can also right-click to demolish existing scenery while using any construction tool.

Land and Water Windows

The **Land** tool lets you create hills, dig holes, and change the color and texture of your landscape. The **Water** tool lets you create bodies of water — a prerequisite to building some types of water rides.

Clicking on the **Land** or the **Water** button opens a window where you can choose the size of the "brush" you will use to alter the landscape. Only the **Land** window lets you assign color and texture to the areas you modify.

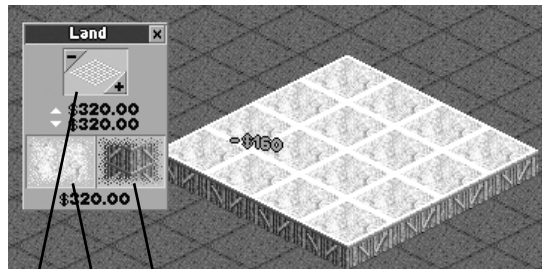

A B C

TIP
While playing the game, you are always charged for altering land and water squares.



A. Brush Size – This shows the size of the area that you will affect by clicking on the landscape. Brush size ranges from one square to a 5-by-5 grid (maximum size in the Scenario Editor is a 7-by-7 grid). To increase or decrease the size of the brush, click the **[+]** or **[-]** buttons.

B. Surface Texture (Land only) – Click and hold this button to display the available land surface textures. Move your mouse cursor over a texture and release the mouse button to select it.

You can toggle a texture ON or OFF by clicking on it. When the texture icon has an "indented" look (like a pushed button), then it is ON, and clicking the landscape or raising or lowering an area of land applies the current texture to its surface. When the texture icon does not have an "indented" look, you do not apply a new texture when you excavate.

C. Edge Texture (Land only) – This lets you choose the texture that is applied to the vertical edges of excavated land. It is functionally identical to the **Surface Texture** tool, explained above.

Real Roller Coaster V2 – Vertical Velocity



RCT2 Coaster Type: Inverted Impulse Coaster

Specs: Twin 185-foot towers; 630 feet long; 70 mph max

Special Features: Electromagnetic propulsion system launches train 70 mph in less than 4 seconds — straight up and straight back down two vertical towers. First tower features spiraling corkscrew near top.

Location: Six Flags Marine World – San Francisco

**Coaster type only featured in game — not actual ride.*





Raising and Lowering Land

When you're using the **Land** tool, the cursor becomes a shovel, with an arrow pointing to the center of the grid that defines the size of your brush. When

TIP

You can only fill an area with water from the ground up. If you want water at or below ground level, you must lower the land first.

you're using the **Water** tool, the cursor looks like waves, also with an arrow pointing to the center of the grid.

To raise or lower land or water, click and hold the mouse button. Push the mouse up and a chunk of land or water the size of your brush will rise up from the landscape. Pull the mouse back down to lower an area the size of your brush. Release the

mouse button when you're done.

When you raise or lower a large area of land or water, the lowest parcels rise and the highest drop first, until every square is on the same level. Then, the area moves as a whole.

Land and water is raised in 5-foot, 1.5 meter or single-unit increments (you can set the type of unit displayed in the **Options** menu). You are charged for each square that you raise or lower. You are also charged for applying a new texture to a square of land, which you can do simply by clicking the land with textures toggled ON (see page 25).

Sloping Landscape

You will notice that when you raise or lower land using a large brush, the edges rise straight up

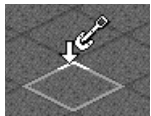

with no slope whatsoever. To remedy this sheer cliff look, you've got to fine-tune the edges and add a nice slope to your raised or lowered land.

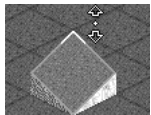

To do this, use a one-square sized brush, which lets you adjust each corner of a land square separately.

If you position the mouse pointer near a corner of the land square, that corner is highlighted. Click and hold while you move the mouse to raise or lower only that corner. Release the mouse button when you're done.



Scenery

Thrill rides and junk food aren't the only things that make an amusement park great. Atmosphere is also tremendously important, and you must provide carefully planned landscaping and scenery to make your park guests happy. By creating a more appealing environment, you significantly add to the enjoyment your guests derive from the park, and you can also add intensity and excitement to your rides.

The **Scenery** window includes all of the decorative elements you can use to beautify your park. It has a number of tabs, each of which displays a different selection of scenery items. The tabs that are available to you depend on what scenario you are playing, and what your researchers have discovered.

Click each tab to view and use the items in the corresponding window. (You might have to use the slider bars to see all of the available choices.) Place your cursor over a scenery item to display its description in the lower left corner of the window, and its price in the lower right corner. The cost of scenery items varies by type.

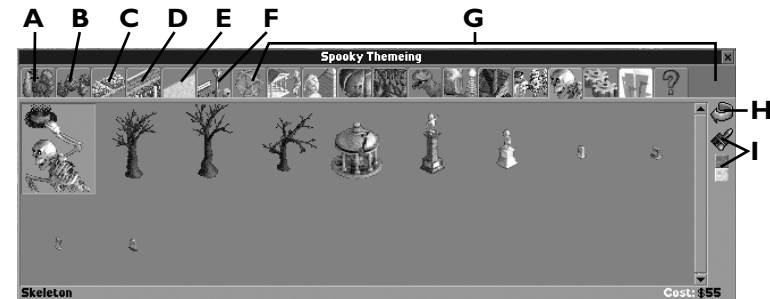

A. Trees – Trees take up one square of land and provide both shade and beauty to your landscape. Once you plant a tree, you must pay to remove it.

B. Shrubs & Ornaments – You will find bushes, fountains, exotic plants, statues and even topiary (bushes trimmed to resemble animals and fanciful objects) in this category. Use them to create pastoral gardens or decorative themes. Not all shrubs and ornaments take up a full square — some occupy only a half or quarter square.

Once shrubs are in place, you must pay to remove them. You recoup a bit of cash by removing statues and fountains.

TIP

You can click the right mouse button to remove scenery or paths while using any of the construction tools.



C. Gardens – Rock-bordered and filled with flowers, gardens come in a variety of colors, combinations and sizes. Once these are in place, you must pay to remove them.

D. Fences and Walls – Fences, hedges and other decorative boundaries are perfect for edging paths, rides and scenic gardens. These are always placed on the edge of a land square, and you can create double walls (or fences) in adjacent squares. Since fences do not fill an entire square, you can often place another item of scenery quite close to it. You get no refund when you remove these objects, nor do you pay a fee.

TIP

Many guests prefer to sit when they eat. Provide a good supply of benches conveniently located near any collection of food stalls.

E. Walls and Roofs – This tab contains walls and roofs that you can use to make decorative structures and buildings. The wall objects behave like the fences and walls described above. Roofs generally take up a whole square, and are designed to be put atop walls. (See “How to Place Elevated Scenery” on page 30.)

F. Footpath Accessories – This tab includes such necessities as benches, litter bins and street lamps. These are vital to your park’s efficiency and cleanliness, and to the comfort of your guests. You can only build these accessories on footpaths — benches only on the flat footpath sections. You get no refund when you dismantle these objects, nor do you pay a fee.

F. Signs – Also found under the **Footpath Accessories** tab, signs are a unique scenery item that let you put scrolling marquees across your paths, alerting and entertaining guests (and players).



You can only place signs across paths. When you place a sign, the **Banner** window pops up. Here you can: (1) enter a message up to 30 characters; (2) turn the sign into a No-Entry marker; (3) delete the sign; and (5) change the color of the letters.

G. Theme Items – If you instruct your researchers to think about Scenery & Theming, they will eventually discover new ways for you to smarten up your surroundings. Themes range from Classical to Abstract, and appear under separate tabs in the **Scenery** window. Items fall into all categories, including signs, trees, shrubs, fountains, statues and fancy animated decorations. All in all, definitely worth your research dollars!



H. Rotate – Click here to rotate an item before you place it. The items in the **Scenery** window will rotate to show their new orientation. There is neither need nor opportunity to rotate some items, including fences, walls and footpath accessories. These and other items automatically orient themselves when placed in your park.

I. Paint – You can recolor some items, including some signs, fences, and theme objects. To change the color properties of an object, click on any of the

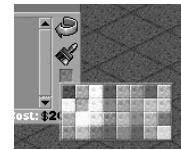

three **Color** buttons to display a color palette. Choose a color and certain elements of items that can be recolored in the **Scenery** window will change to that color. Items that cannot be recolored will be unaffected.

TIP

Scenery and theme items placed near the track can add to the excitement of a ride, especially when you create the illusion of an impending collision. Tracks that cross over or under other parts of your park — footpaths, terrain, other rides and such — are also more exciting.

How to Place Scenery

Putting scenery in your scene is simple:

1. Click on the picture of the item you want to add to your landscape.
2. Use the Rotate button to orient the object, if necessary.
3. Use the Color buttons to recolor the item, if necessary.
4. Move the cursor to the area where you want to place the object. The cursor highlights the land with a shadow image of the object that shows its size and the space required. Click to place the object in your landscape.

You can demolish scenery and paths that are in your way by clicking with the right mouse button on the object on the landscape that you want to remove.

Note: Most items are restricted to certain locations. (Signs, for example, must be built across a path.) The cursor will not highlight if you are unable to place the object in your current location. If the cursor highlights but you still cannot place that particular item, a text window will pop up that explains why. (Hint: Sometimes rotating the object will make it fit.)



How to Place Elevated Scenery

If you need to place an object, such as a roof or a wall, at an elevation above ground level, hold the **Shift** key once your cursor is over the area where you want to place the item (but before you click the mouse). Now, as you move the mouse, the object will rise in the air or even drop below the land surface. Click to place the object at the desired location and height.

Alternatively, place the cursor over a scenery object that you want to match the height of (for example, a section of roof) then hold down the **Ctrl** key to “lock” your cursor to that height. Then, move the cursor around and you’ll see that whatever you are building will also appear at the same height.

This can be combined with the **Shift** key: hold down **Shift** and **Ctrl** simultaneously to raise or lower the scenery a bit (and lock it to that height) before building it.

TIP

Keep an eye on stacked items. When using the **Shift** command in stacking land objects, rotate the map frequently and look at your work from all angles. Sometimes you may be placing a piece in the wrong spot.

Real Roller Coaster X



RCT2 Coaster Type: Multi-Dimensional Coaster

Coaster Specs: 200 feet tall; 3,610 feet long; 76 mph max

Special Features: Unique design allows vehicles to spin independently 360-degrees head-over-heels on a separate axis — first drop is 200 feet and 89 degrees.

Location: Six Flags Magic Mountain – Los Angeles

**Look for this ride in the Six Flags Magic Mountain scenario.*



Footpaths and Queue Lines



You will get to know the **Footpaths** window well during your *RollerCoaster Tycoon 2* career. The humble footpath is the lifeline of your park — without proper paths, your guests can’t find your park attractions, and without proper queue lines, guests can’t ride your rides.

Placing basic paths is as simple as clicking a connected line of squares on your landscape. Raised paths and tunnels are somewhat trickier, but not that difficult once you get the hang of it. Click the **Footpaths and Queue Lines** button to open the **Footpaths** window.

Path Types

The top two buttons in the Footpaths window let you choose the type of path to build.

A. Footpaths – These give your guests a way to move between areas of your park. Use them to connect virtually everything in your park.

B. Queue Lines – These are used to connect a ride Entrance to the main path. You should not use a queue line for any other purpose, as it might confuse your guests. Every ride must have at least one section of queue line attached to its Entrance. The more popular the ride, the longer its queue line should be. The first section of

queue that you place adjacent to an existing path becomes the entry to the queue line.

Clicking and holding either the **Footpath** button or **Queue Line** button displays your current choices of path styles. Depending on the scenery you have researched, more path types may be available.

Click on the path type, then move your cursor over the style you want and release the mouse button to select that style.

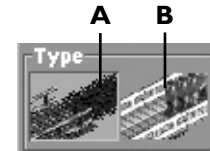

TIP

Provide transport rides from point to point (every point near a ride) around the park. This will lighten the traffic load on your path system and give tired guests an alternative to walking.



Building Paths

At the bottom of the **Footpath** window are two buttons that allow you to specify the path building mode.

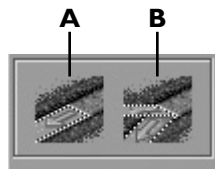

A. Conform to Ground – This is the default path-building mode, and lets you build footpaths on flat and diagonally sloped land, but not on irregular surfaces. To place a path segment, position the mouse cursor where you want a new (or differently paved) path, then click. Right-click to remove existing sections of a footpath.

For longer paths or large sections of pavement, you can hold the mouse button and drag the cursor over the terrain. Release the mouse button when you're finished. You are charged for every path section you place, and receive a partial refund when you remove a footpath or queue line.

B. Free Path – This allows you to construct supported paths that defy the slope of the land. Use this mode to create raised paths, bridges, tunnels and piers. The higher or lower you build a path, the more expensive each section. You are refunded a standard rate when you remove a path, no matter what it cost to place it originally.

To build an elevated path or tunnel, click the **Free Path** button. Your cursor will become an outline square with a yellow arrow in it.

Move your cursor to a side of the outlined square to make the arrow point toward it. This is the direction that the first path piece will face when you click the mouse.

Position the cursor on the square you want to build from, not on. For example, if you want to build a queue line attached to an elevated ride Entrance, position the outline square on the Entrance and move the cursor until the yellow arrow points away from the Entrance.

TIP

Keep the distance between attractions short, so that no guest has the opportunity to become bored or overly tired while walking from one attraction to another. When a long walk is inevitable, provide benches along the way, especially at the top of hills.



Once you click the mouse to place the first piece, several new buttons become available.

A. Direction – These arrows determine the direction of the next section you build. To change the direction of a path segment, click the appropriate arrow button. The path will highlight to show you what the next segment will look like when you place it.

B. Slope – The three slope buttons control the inclination of the next section of path. If no next section of path appears (you see only the pointer arrow), it means that you cannot build the section with the slope you have selected in that location. You may need to use the **Demolish** button to back up a step and alter the slope.

C. Build This – Click on this button to build the next path section. Before you build, check the cost of the section listed at the bottom of the button. The more support a section needs (the higher a bridge or the lower a tunnel), the more expensive it is to build.

D. Demolish – This removes the path section you have just built — not the highlighted section (which isn't built yet). You can also use the right mouse button to remove sections of any type of path, as well as most objects in your way.

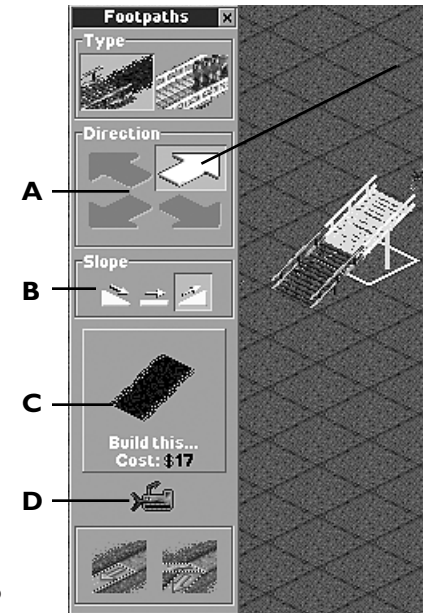



RIDE CONSTRUCTION

It goes without saying that the main reason guests visit an amusement park is for the rides. Serene scenery, themed gardens and nicely laid footpaths help keep guests happy, but the rides are what it's all about. Remember, variety is key in building rides. After all, would you visit a park that had fifteen merry-go-rounds and nothing else?

Click the **New Ride** button to open the **Ride Selection** window. This contains the tools you will use to construct everything from restrooms to roller coasters.

The **Ride Selection** window tabs correspond to the categories of rides and attractions. Click on a tab to see what rides are available to build in each category. **Note:** As you complete research projects, new ride types might be added to a category.

Within each category, you can move your cursor over the picture of a ride to get more information. All the pertinent details on the attraction you select appear in the lower half of the **Ride Selection** window. Among other important data, this readout always includes the approximate cost of construction.

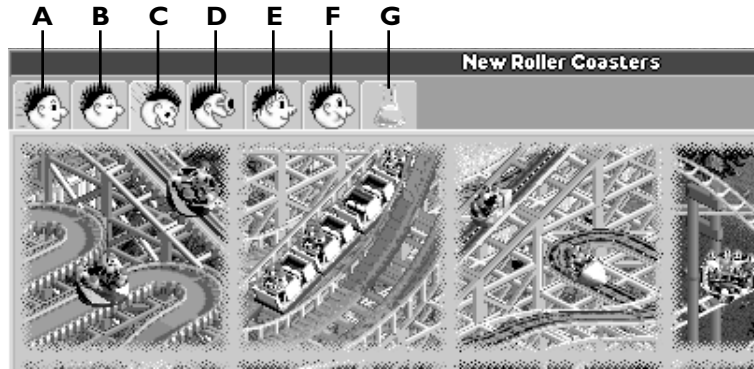

A. Transport Rides – These slow-paced people-movers include miniature trains, monorails, cable cars and the like. You can (and are sometimes required to) build multiple stations as destination points. Use transport rides to give guests a scenic view of your park attractions while ferrying them from one location to another. (If guests have to walk too much they can get overly tired and cranky.)

TIP

Elevated rides allow your guests to see other rides and areas of the park, which can spark interest in visiting them.



TIP

Covered rides are more popular when it's raining.

space than more intense attractions.

C. Roller Coasters – These are the big draws of any successful park. Wooden and steel coasters are only the beginning. Depending on the scenario and your research, you could have access to many types of coaster technologies designed to twist the lunch from your brave guests' guts.

There is at least one standard design available for every type of roller coaster. Hold your cursor over a design name to see its statistics and what it looks like. This also reveals two self-explanatory buttons: **Toggle Scenery ON / OFF**; and **Rotate**. Other ride types that feature pre-built designs, including some gentle rides and water rides, also work this way.

D. Thrill Rides – These fill the intermediate range in intensity between mild rides and roller coasters. This category can include the kind of swinging and spinning belly-churners found at your average county fair, as well as old-time favorites like bumper cars.

E. Water Rides – Especially in a hot climate, there is nothing better than a ride that gets your guests all wet. Water rides include everything from rented rowboats to water slides and high-velocity H₂O coasters.

B. Gentle Rides – These low- and no-thrill rides are suitable for all guests (especially children). The Ferris wheel and merry-go-round are examples of gentle rides. Most gentle rides do not involve custom design and tend to take up less

Real Roller Coaster Titan

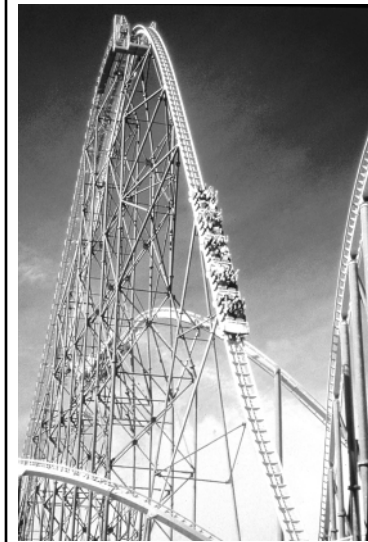

RCT2 Coaster Type: Hyper-Twister Coaster

Stats: 255-foot initial drop; 5,312 feet long; 85 mph max speed

Special Features: Three-and-a-half minute ride through spirals, camelback hill, carousel curve, 120-foot dark tunnel, and more — long and FAST!

Location: Six Flags Over Texas – Dallas

**Look for this ride in the Six Flags Over Texas scenario.*





F. Shops and Stalls – Your park will need a number of non-ride facilities, including food stalls, souvenir shops, information booths and, of course, restrooms.

G. Research – Click the **Research** tab to show the most recent research discovery, the current research project, and its expected completion date. Click the **R&D Funding** button (1) to open the **Research Funding** window. Click the **Invention Details** button (2) to go straight to this new ride.

TIP
Riding less intense rides near a coaster can often help guests get up the nerve to ride the more extreme attractions. Consider surrounding a roller coaster with less intense rides.



Building a Ride

Ride-building is covered in detail in the in-game Tutorials, as well as in the “Creating a Coaster” section on page 52. Here’s a brief rundown of the necessary steps involved:

1. Click the **New Ride** button to open the **Ride Selection** window.
2. Using the tabs, choose a type of ride.
3. Select a ride by clicking its picture.
4. Determine the location and orientation of the ride, then click the spot on the landscape where you want to build it. For some rides, building is a single-click process; for others, like custom-designed roller coasters, building can take some time.
5. Place the Entrance and Exit for the ride.

TIP
Start small. Time ticks by at an easy pace in *RollerCoaster Tycoon 2*. Don't spend too much cash on a big, fancy ride before you know your park can draw a crowd.



6. Create a queuing line to attach the Entrance to a path, and connect a path to the Exit.
7. Test the ride, set an admission price, give it a name and determine its operating characteristics.
8. Open the ride.

Ride Construction Window

The buttons in the **Ride Construction** window differ depending on the type of ride you are building. Here is a brief explanation of what the buttons do:

A. Direction – Click on an arrow to specify the shape of the next piece you will place.

B. Special – Click here to add a special track piece or element to your ride. Selections vary with the type of ride you are building, as well as the slope you are on and the piece you just built. Possible choices include brakes, on-ride cameras, loops, corkscrews, S-bends, station platforms and more.

C. Slope – Click here to specify the slope of the next track segment.

D. Special Functions – Special ride functions, such as banked curves and seat rotators, will sometimes appear in this area of the **Ride Construction** window, depending on the type of ride you are building.

E. Build This – Click here to add the next piece to your track, signified by the highlighted piece outline in the **Main View**.

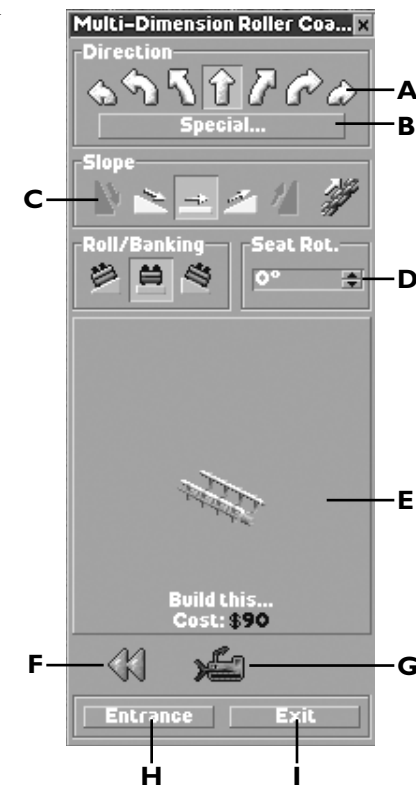



F. Next / Previous Track Segment – Click the forward or reverse arrow buttons to move between placed track pieces. The currently selected track piece will be highlighted.

G. Demolish – Click the bulldozer icon to demolish the piece of track you just built if you are at the end of a track, or the highlighted piece of track if you are working in the middle of the track.

H. Entrance – Click here to place an Entrance building. You must place the Entrance adjacent to a segment of station platform. This option is chosen automatically as soon as you place a pre-built ride.

I. Exit – Click here to place an Exit building. You must place the Exit adjacent to a segment of station platform. This option is automatically chosen after you place a ride Entrance.

TIP
You can quickly select any track segment by right-clicking on it. A ride must be closed before you can work on it.

Caring For Your New Ride

Every ride in your park has a **Ride** window associated with it. This window opens automatically as soon as you finish constructing a ride. You can also open a **Ride** window by clicking on a ride in the **Main View**, or by selecting its name from the **Rides / Attractions** window.

Different rides have different features and statistics. Below are all available elements in the **Ride** window.

A. View – This window displays various views of the ride you are working with. You can view by car or ride section using the drop-down menu below the row of tabs. There are five buttons on the right side of the **View** window, indicated by numbers in the above screen:

1. Open / Test / Close – After you build a ride, you must test it to see if it's safe to open to the public. Testing a ride also lets you (and your guests) know how intense, exciting and nauseating it is. (Not all rides require testing. Those that don't simply have the options to Open or Close.)



2. Construct – This opens the **Ride Construction** window and lets you continue work, adjust the Entrance and Exit, or make changes or repairs. You must close the ride before you can work on it.

3. Name – Give the ride any name you want (up to 30 characters long)

4. Snap-To – Shift the **Main View** over to the ride's segment or car displayed in the **View** window.

5. Delete – **WARNING!** This will destroy your ride (but you may get some money back for it).

B. Description – This tab contains the ride description and capacity. This is also where you can set the number of cars on some rides, as well as variables, such as whether a ride starts with cars reversed.

C. Mechanics – In this tab you can set a number of mechanical options, depending on the type of ride. Options can include minimum and maximum waiting time guests encounter, whether to wait for a full or partial load, whether to synchronize with an adjacent ride station (for race-type rides), how fast to run the lift hill, and more.

D. Maintenance Record – This tab gives a snapshot of the ride's reliability and downtime. This is also the place to set how often mechanics inspect the ride. Click the **Mechanic** button to open the **Worker** window associated with the mechanic closest to the ride.

E. Color / Style – Click here to paint your ride, color the cars, and set the style of the Entrance and Exit. Click the **Color** buttons to adjust associated parts of the ride and cars. You can paint some rides in different color schemes by using the **Paintbrush**. Click the **Paintbrush** button, select one of the color schemes, choose the three colors you want to use, then click on track parts in the **Main View** to recolor them.

F. Music – Click on the drop-down menu to choose from several styles of music. Music attracts guests and adds personality to a ride.

G. Ride Statistics – These are elements that will let you know if you have a mild or an exhilarating ride. Not all rides have the same type of stats.

- **Excitement** – How much fun a guest will have.
- **Intensity** – How extreme the gravitational forces of the ride are.
- **Nausea** – The level of queasiness the riders will experience, and an indication of how much lunch you can expect guests to lose just outside the ride.
- **Maximum Speed** – The top speed.



- **Average Speed** – The average speed over the length of the entire ride.
- **Ride Time** – How many minutes the ride lasts.
- **Ride Length** – The length of the ride.
- **Maximum Positive Vertical G's** – The maximum gravitational force exerted on a rider.
- **Maximum Negative Vertical G's** – The maximum negative gravitational force exerted on a rider.
- **Total Air Time** – The amount of time a rider experiences weightlessness.
- **Inversions** – How many times riders can expect to be flung upside down during the course of the ride.

The **Ride Statistics** tab also contains a **Save** button (diskette icon). Click on this to save the track design to disk.

H. Data Log – This tab lets you watch a real-time graph of physics at work on your rides, in four categories: Velocity, Altitude, Vertical Gs and Lateral Gs. On coasters, this is used to identify what spots may need banking pieces to make the ride less intense.

I. Financial Data – Click here for a snapshot of the ride's income, running costs and profits. If you are playing a scenario where you charge admission to individual rides, this is where you set the ticket price.

J. Guest Data – This tab contains statistics related to guests, including how many customers have ridden the ride, its popularity, queue time, and more. There are three buttons on the right side of this window that let you bring up windows related to guests thinking about the ride, riding the ride and standing in line.

TIP

The **Save** button on some rides will allow you to save the track design plus any additional theme objects or scenery around the ride. Click on the objects around the ride that you want saved. You must test a ride and generate statistics before you can save it.



RUNNING A PARK

Building the park is the part of the job that allows you to flex your creative muscles, but that's only half the job. In order to be a successful tycoon, you must both maintain what you've built and manage the business of the park.

Staff

The day-to-day operations of your park can be quite overwhelming. You are responsible for the maintenance of complex machinery that — if something goes terribly wrong — could injure or even kill innocent park guests. The park is overrun daily by hundreds of visitors, and you've got to prevent the less civilized among them from making a mess, breaking things, and ruining the experience for the rest. It seems like quite a task, and it is, but luckily you've got a dedicated staff at your service who, with a little management, will mind the details for you.

Hiring Staff

There are four types of employees to help you manage daily operations. Clicking the **Staff** button opens the **Staff** window, where you can hire and manage park employees.

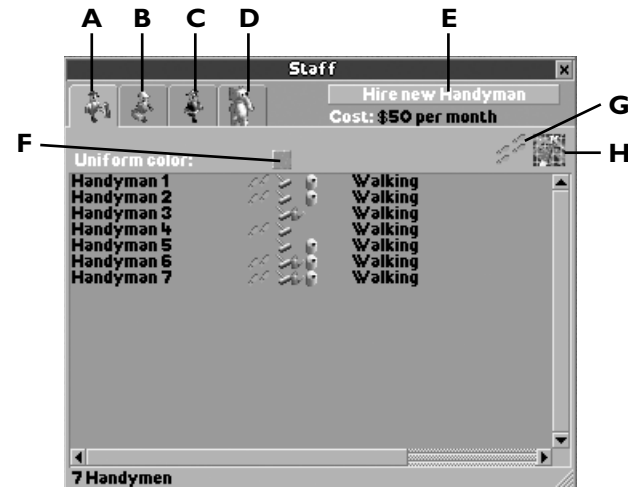



A. Handyman – These tireless workers help empty the trash bins, mow the grass, water the gardens, and, most importantly, keep your paths puke-free! Handymen cost \$50 a month to employ.

B. Mechanic – Hire a mechanic to keep your rides running smoothly, reduce the chance of a breakdown or accident, and fix a ride should it malfunction. Mechanics cost \$80 a month to employ.

C. Security Guard – There always seems to be a bad apple in every bunch. Hire Security Guards to deter the hooligans, who would otherwise cause problems like breaking benches. Security guards cost \$60 a month to employ.

D. Entertainer – There’s nothing like waiting in a long line to make a guest grumpy. Hire an entertainer to keep visitors amused, and assign him to patrol at or near the Entrance to a ride. Entertainers cost \$55 a month to employ.

E. Hire Button – This puts a new employee on the payroll and opens the **Worker** window associated with him.

TIP

If you are going to assign paths to your workers (and you should!), be sure you don’t leave any areas completely unpatrolled. It’s amazing how disgusting a path can get if no handyman ever bothers to sweep it.

H. Mini-Map Button – Click on this to open the **Mini-Map** window, where employees are represented by pulsating dots.

TIP

When vandalism does occur, the best course of action is simply to replace the damaged elements of the park. The longer you leave vandalized objects around, the more it will upset your guests.

F. Color Button – This button lets you change the appearance of your workers’ uniforms.

G. Path Button – This button helps you keep track of where you have assigned your staff to patrol (see “Patrol” on page 43 for information on how to set paths). Click on this button to display the areas that you have assigned particular staff members to patrol. Patrol areas will be highlighted in the **Main View**. Click on a highlighted area in the **Main View** to open the **Worker** window associated with the staff member assigned to that area.



Managing Staff

Use **Worker** windows to oversee and direct your staff. You can open a **Worker** window by clicking on one of your staff (in the landscape display) or selecting him from the list in the **Staff** window. The title bar shows the worker’s name (you can rename him). There are three tabs, each of which opens a display.

A. View – This useful tab shows you an up-close view of the worker as he performs his duties throughout the park. This window has five buttons on the right side, indicated by numbers on the above screen.

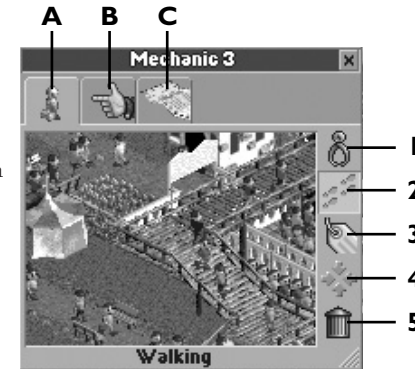

1. Grab – Click on this to pick up the worker and move him to a specific place.

2. Patrol – Click on this button to confine an employee’s duties to a specific area of the park. While this button is depressed, assigned patrols for all of that staff type show up as a highlighted grid in the **Main View**. Other workers’ patrols are outlined by a gray grid; the current worker’s patrol is outlined by a blue grid. Click on the landscape to mark the area you want the worker to wander.

3. Rename – Click here to rename this worker.

4. Snap To – This button centers the **Main View** on the worker’s current location.

5. Sack – Click here to terminate the worker’s contract and end his employment with the park.

TIP

The **Grab** button is the fastest way to get a handyman to the scene of a mess, but it is not helpful for getting a mechanic to fix a broken ride. When you pick up and move a mechanic, you cancel his current assignment. To make your mechanics more efficient, assign organized patrols to them. Keep in mind, however, that a mechanic will not leave an assigned patrol area to fix a broken ride.



B. Orders – This tab lets you control specific tasks for each staff member. Click the box next to a task to make it part of that worker’s duties. A checked box indicates that staff member will do that job.

- Handymen have four possible jobs: sweep footpaths, water gardens, empty litter bins, and mow grass.
- Mechanics inspect and repair rides.
- Entertainers simply change costumes. Click the drop-down menu in the **Orders** tab to tell them what to wear.
- Security Guards’ jobs are so straightforward that you need not and cannot give them any orders (beyond assigning them a path).

C. Statistics – This tab gives you information on the employee’s monthly wage, when he was hired, and what he’s been doing since you hired him.

Managing Rides and Facilities

Once your rides are up and running, you’ll appreciate the **Rides / Attractions** button, which provides a one-stop spot for dealing with all the rides and facilities in your park. The **Rides / Attractions** button contains several options:

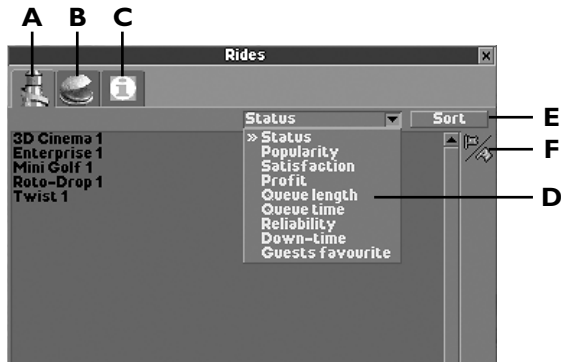

A. Rides – Lists all of the rides in your park. Click on a ride name to open its associated **Ride** window.

B. Shops & Stalls – Lists all of the Shops and Stalls in the park. Click on a name to open its associated window.

C. Information Kiosks / Guest Facilities – Lists all of the Information Kiosks, Restrooms, First-Aid buildings and Cash Machines in the park. Click on a name to open its associated window.



D. Information Type – This drop-down menu lets you change the information displayed in the information column. Information listed varies, but can include:

- **Status** – How many people are on the ride, and whether it is broken or running.
- **Popularity** – The percentage of guests who choose to ride a ride after considering it.
- **Satisfaction** – The rating given a ride by guests after they ride it.
- **Profit** – How much a ride is earning or losing.
- **Queue Length** – How many people are waiting in line for the ride.
- **Queue Time** – How long people are waiting before getting on the ride.
- **Reliability** – Percentage that the ride is in operation.
- **Down Time** – Overall time the ride is spent broken down.
- **Guests Favorite** – The rides that your guests love the most!

E. Sort – Click here to sort the list according to the information type you’ve chosen.

F. Open / Close – Open or close all rides from here with a single click.

TIP
Provide something for everyone. Yes, roller coasters are the focus of the park, but not everyone enjoys riding them. Even those who do want to ride something else now and again. Maintain a balance of rides running the gamut from mild to intense, and you will maximize the number of people you satisfy.

Caring for Guests

The satisfaction of your park guests is probably your most vital concern. Happy visitors stay in the park, spend more money, and (through reputation and word of mouth) draw other guests to your site. Unhappy guests leave with cash in hand.

TIP
One of the benefits of the Information Kiosk is that it provides maps of the park to your guests (at a price you control). Having a map handy significantly reduces a guest’s chances of getting lost.

How do you know what your visitors are thinking and feeling? As manager, you have access to powerful polling and reporting tools that let you monitor the thoughts and actions of every guest in your park. There are plenty of ways to get this data, and the **Guest** window associated with each of your visitors is probably the best. This window is also handy for corralling the occasional stray guest.



Individual Guest Window

The simplest way to open a **Guest** window is to click on any park visitor in the **Main View**. You can also open individual **Guest** windows by clicking on a name from the **Guest Summary** window, which you can open by clicking on the **Guest** button at the top of the screen.

The title bar shows the guest's assigned name (you can rename them if you like — see below). Here are the tabs and buttons you'll find in the **Guest** window:

A. View – Shows a close-up view of where the guest is in the park. There are four buttons available on the right side of the **View** tab, indicated by the numbers in the screen above.

1. Move – This button lets you pick up and move a guest. This is helpful when you want to relocate someone who is lost.

2. Name – Guests come in with names, but you can call them whatever you want. Click here to rename any guest.

3. Snap To – Click here to center the **Main View** screen on this guest's current location.

4. Tracking – Click on this button to turn tracking ON or OFF for this guest. When tracking is ON, this guest's actions, such as entering or leaving a ride, are reported in a message at the bottom of the **Main View**.

B. Stats – There are a lot of thoughts and emotions running through your guests' little brains. (Each guest enters the park with their own unique combination of feelings and desires.) This tab gives a closer look at levels of Happiness, Hunger, Thirst, Nausea and more. It also lists his or her time in the park, preferred ride intensity and nausea tolerance.

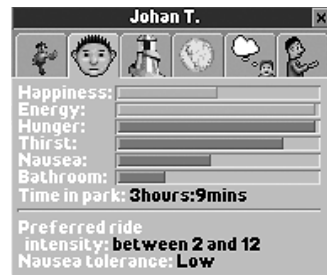
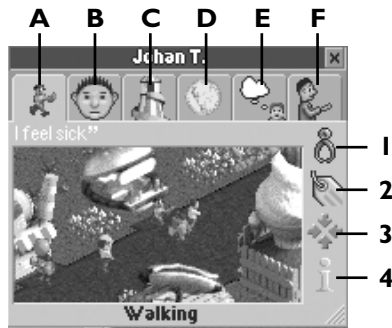

C. Rides – This shows what rides the guest has been on and which is his or her favorite.

D. Cash Info – Click on this tab to see how much money the guest has and where he or she has been spending it.

E. Recent Thoughts – Use your incredible mind-reading powers to see what the guest really thinks about the park!

F. Carrying – This tab lists what the guest is currently carrying.

TIP
Don't let guests stay lost — a visitor who wanders away from the main attractions is not having fun. Maps of the park can prevent this, and a sharp-eyed park manager (you) can spot and retrieve lost guests.

Guest Summary Window

The **Guest Summary** window is a good tool for a getting quick snapshot of where you are doing things right (and wrong) in your park. It contains a summary of actions and thoughts for individuals or groups of people in your park.

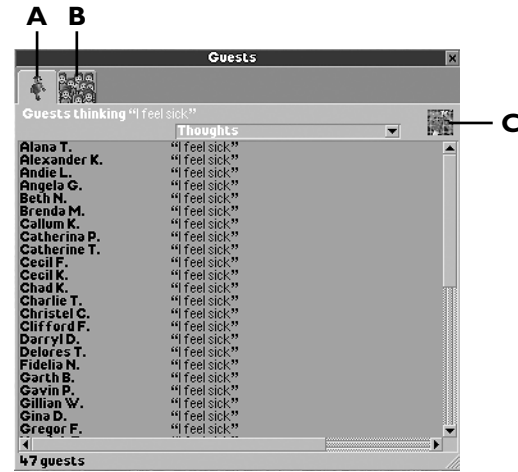

A. Guests – This tab shows an alphabetical listing of guests in the park. If you open the **Guest Summary** window using the **Guest** button, this window displays all of your guests. If you open this window using a button from a **Ride** window (such as "Guests thinking about this ride"), it includes only those guests associated with that button. Click the drop-down menu to switch between actions and thoughts.



B. All Guests (Summarized) – Click here to see a summarized list of guest thoughts or actions, including the number of guests who are doing or thinking about a particular thing. Click the drop-down menu to switch between actions and thoughts. Click on a thought or action to list those guests in the **Guests** tab.

C. Mini-Map – Click here to open the **Mini-Map** window. The guest or guests currently listed in the **Guests** tab are displayed on the map as bright, pulsating dots. Use this feature to help pinpoint where guests feel overcrowded, for example, or overly grossed-out about the state of the paths.



Other Guest Information

Every **Ride** window includes a **Guest** tab with buttons that summarize what guests think about the ride, as well as what they are thinking about as they ride it or stand in line. Click on any of these buttons to open the **Guests Summary** window.

Watch the **Rating** bar in the **Status Box** (lower left corner of **Main View**). Position the mouse pointer over the bar to see the actual rating. This number (between 0 and 1,000) reflects your guests' overall impression — of ride design, park layout, tidiness, value, efficiency, and more. This is a great barometer of your park's success or failure, although the rating will never tell you what a problem is, only that there is a problem.

Finances

Finances might not be the most glamorous aspect of *RollerCoaster Tycoon 2*, but ignore them at your peril. Face it — you can't build new rides and maintain what you've got if you've got no cash to do it. Sure, there's always the bank, but even the ultra-generous *RollerCoaster Tycoon 2* bankers will cut you off at some point.

Fortunately, managing money is simpler than you might suspect. Most of the detail work is done by reliable lower-level managers and accountants. Having all that expertise at your disposal does not, however, mean that you can ignore the bottom line. If you're not watching the store, no one else will do it for you.

In each scenario, the park comes "as is" — you need not purchase the existing land and attractions, but you must pay upkeep where appropriate. You have borrowed a certain amount from the bank to make improvements to the park under your management. This loan constitutes your working capital, also called



cash-on-hand (COH). That and whatever income you derive from guest spending in the park are your only sources of funding. Improvements, salaries and upkeep are your expenditures.

TIP

It can pay to monitor the weather and make adjustments to what you are selling, like raising prices or building a coffee stand when the temperature dips, or erecting more drink stands if the climate is hot.

Fiscal Reports

Park finances are not tricky — as long as you pay attention to where your money is going. Luckily for you, there are a number of reports to help you do so. Let's start with the most informative — those in the **Finances** window.

Click the button in bottom left of the screen to open the **Finances** window. It contains six tabs:

	March	April	May	June
Expenditure/Income				
Ride construction				
Ride running costs				
Land purchase				
Landscaping				
Park entrance tickets	-\$1,175.00	+\$10.00	+\$10.00	-\$12.00
Ride tickets				
Shop sales				
Shop stock				
Food/drink sales				
Food/drink stock				
Staff wages				
Marketing				
Research	-\$200.00	-\$200.00	-\$200.00	-\$50.00
Loan interest	-\$60.80	-\$60.80	-\$60.80	-\$15.20
Loan:	\$10,000	at 5% per year	Park value: \$0	Company value: -\$2,014
Cash:	\$7,985.40			

A. Financial Accounts – This includes a detailed monthly breakdown of your income and expenses. It is the most in-depth financial report; use it to track exactly where your money has come from and where it has gone. Click on the up and down arrows next to **Loan** at the bottom of this tab to borrow more money or pay off your current loan.

B. Cash Graph – This tab shows a graph of your COH, minus the total amount of your loan from the bank, over time. The current total is noted at the top. Unless your COH exceeds the amount of your loan, this number is red to indicate that it is negative.



C. Park Value – Click here to see a graph of your park value — a somewhat elusive number calculated to reflect what the park is worth. The park value figure is derived from the value of the land and equipment owned, the quality and profitability of the rides and the park as a whole, and the park’s overall public reputation, as determined by the Park Rating.

D. Weekly Profit – This graph shows your weekly profits, and is the most volatile of all the statistics presented here, because each data point reflects a relatively short time period. The Current Profit, listed at the top is an important indicator. If this is a negative number, it means you’re losing money, and better start doing something about it.

E. Marketing – Marketing is used to get the word out to people who haven’t come to your park yet. The **Marketing** window contains six marketing options, ranging from free vouchers to ad campaigns, with a price listed for each campaign. Click on a marketing campaign to open a window where you can set the number of weeks that you want the campaign to run, then click on a button to start the campaign.

TIP

Marketing entices more guests to visit your park, but be careful. If you lure them in with a campaign, make sure you meet your end if the deal. For instance, if people come to the park because you run a “Half off the admission price” campaign and you don’t have any admission price, they may feel cheated!



F. Research – There is usually more than meets the eye when you begin a scenario. Research will eventually reveal the hidden and extra elements that are not available at the beginning of a scenario. The more money you spend per month on research, the faster you will discover the other rides, shops, coasters and scenery that you can use to craft your amusement park.

The drop-down menu in the **Research** tab lets you set the monthly amount you spend on research (none, minimum, normal and maximum funding). You can also tell your scientists what to focus on. For example, you can dump all your research funds into discovering new water rides and scenery before the summer season begins.

TIP

Novelty is king. A ride that is newly built and opened attracts more guests than one that has been running and available for a couple of years. Old rides just don’t excite your guests as much as something fresh.

Real Roller Coaster Texas Giant



RCT2 Coaster Type: Wooden

Stats: 143 feet high; 4,920 feet long; 62 mph max

Special Features: One of the tallest and fastest wooden coasters in world. Initial drop of 137 feet at 53-degree angle is followed by banked curves and 21 drops.

Location: Six Flags Over Texas – Dallas

*This ride featured in the Six Flags Over Texas scenario.





CREATING A COASTER

Coaster building is a creative art that needs to be developed over time, and refined through experimentation, success and even failure. When you build your first coaster, it's a good idea to make it small but complete. This will let you concentrate on the basics and not get lost and frustrated trying to cram all the latest, greatest technologies into a single ride.

Once you are comfortable building, slowly add additional pieces to your existing ride, or build a slightly more complex design. Remember, the goal is to have fun and create!

Roller Coaster Designer

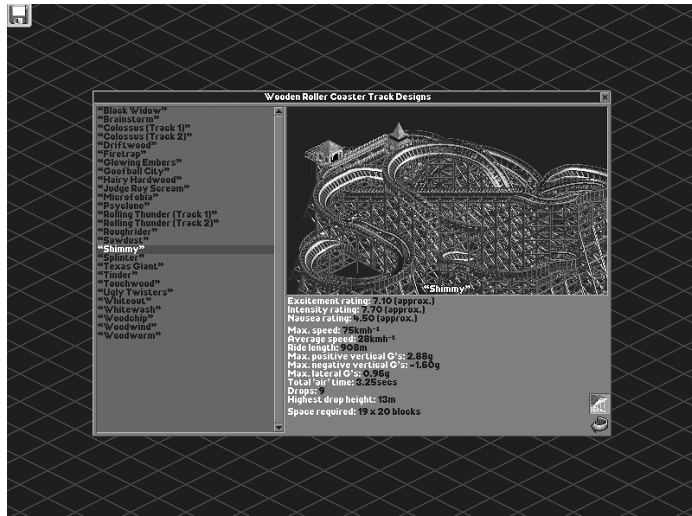

To create a ride without distraction, use the Roller Coaster Designer. Click the **Options** button in the **Main Menu** and choose Roller Coaster Designer to begin.

Your first step is to choose a ride type from the **Select Ride Types and Vehicles** window. (You can select up to four ride types so that you can, for example, design rides that intertwine with each other.) Click the type of rides you want to build in this session and then click the **Forward** button in the lower right corner to continue.



A modified version of the **New Ride** window is displayed. Click the picture of the type of coaster you want to build. A new window will open that shows available pre-built rides, along with images, statistics, a **Scenery ON / OFF** button, and a **Rotate** button. Click on an existing design or click on **Build Custom Design** to go to the **Main View**.

Start building your coaster! (See page 37 for more details on the **Ride Construction** window.)

When you are finished, test and save your ride. This will make it available in future games.

Coaster Checklist

Although you can theoretically build a coaster using less, here is a good basic guideline for the elements required to make a workable, profitable coaster:

- At least two pieces of connected Station Platform track (one for the Entrance, and one for the Exit)
- Ride track that begins at the station platform's start and reconnects to the station platform's rear in a continuous loop
- Medium incline track with pull chain
- Initial slope downwards after the pull chain ends, to build speed and allow cars to complete the circuit.
- Banked track on curves to reduce excessive forces and tone down the intensity
- Special track pieces (like loops, or helices) to add fun and excitement
- Station Entrance
- Station Exit

TIP

Use height markers on track supports to ensure that loops and hills are successively lower, so that your coaster trains have enough speed to make it over the bumps and around the track.



Simple Sample

With those basic components in mind, we'll show you how to build a simple but elegant corkscrew coaster. It's not the fastest or the fanciest, but it works just fine, and may earn you a buck or two.

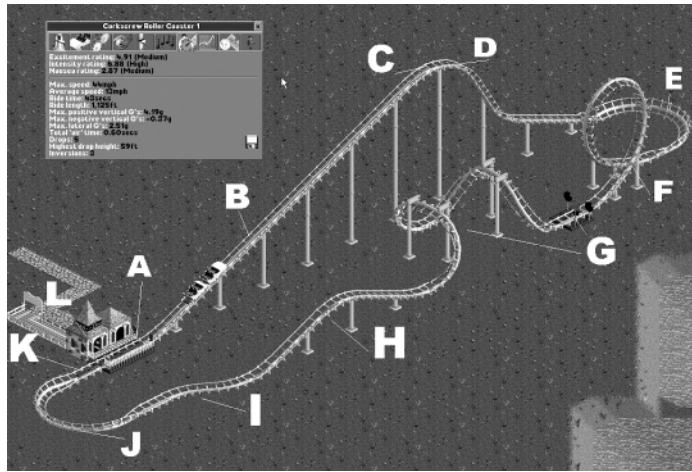

A. Station Platform – If you have only two pieces, your train will be very short. A short car is not always best, since a longer one will generate more speed and momentum. You probably want to add a long station platform, but for this example we'll stick with the minimum.

B. Pull Chain – In most cases you'll need medium incline (upwards) track with a pull chain to get the cars up the initial slope. Some rides can use the steep incline, and others have "power-launch mode," which may not need a chain at all.

C. Apex – This is where we stop using the pull chain and begin the downslope. Here is where a longer car would be more fun. The people in the front would dangle at the edge waiting for the rear car to get over the hump. YIKES!

D. Dropping In! – This is where the slope actually begins. We used one medium piece and one steep piece, followed by more mediums. The cars will zip down here and gain enough momentum and speed to complete the rest of the track.



E. Bank on It – Since the car is moving fast and heading into a turn, we used "banked" curve pieces to help absorb the forces. This keeps your riders from getting overly yanked around.

F. Get Loopy – Coming out of the banked curve, we placed a medium incline piece so that loop pieces would show up in the "Special Track" menu. We then added a nice vertical loop.

G. Say Cheese – We added another Special Track piece: an On-Ride Photo. This will help generate money, and increase the ride's popularity. We followed this with additional special pieces — half-corkscrew left and right. Hope you had a light lunch!

H. Oooh, My Tummy! – Next we put in a little hill for a bit of tickle (air time), and to absorb and use the car's momentum.

I. Lining It Up – Here we knew the track pieces would need to be connected one more square over, so we used a special piece called an S-bend.

J. Almost There – More banked pieces absorb the shock and slow the cars down a bit.

K. Whoa! – The last piece before the station platform is yet another specialty piece called Brakes, which will really slow the car down for safety.

L. Open for Business – When everything connected up, we placed Entrance and Exit buildings.

The next step was to test the coaster. Tests generated the following statistics:

- Medium Excitement rating
- High Intensity (but not too high to ride for some)
- Medium Nausea rating

Again, this is a relatively simple track. Your challenge is to experiment and make the wildest, wackiest, most hair-raising coasters imaginable.

Don't forget to add scenery!



Managing Your Track Design

If you have downloaded or copied rides from a source outside the game, or saved rides in a folder other than the default Tracks folder, you can add them to your available rides using the Track Designs Manager. This simple but important tool lets you rename and delete rides from the **Ride Building** window. You'll find the Track Designs Manager by clicking the **Tools** button in the **Main Menu**.

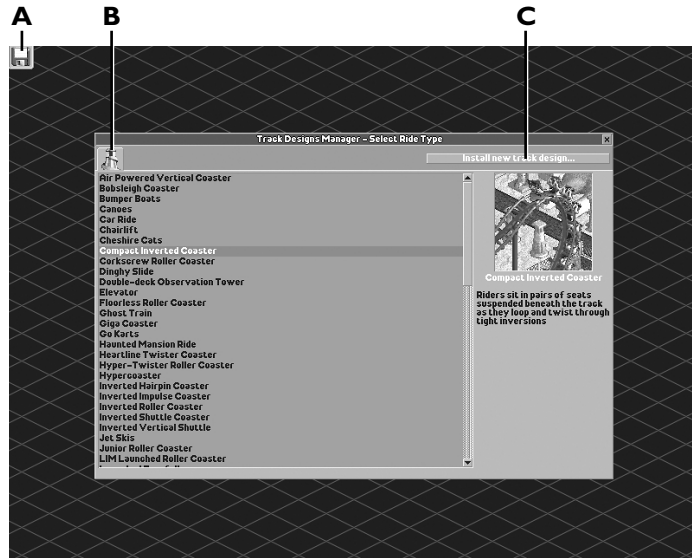

A. Disk and Game Options – The choices in this menu are About RollerCoaster Tycoon 2, Options, Screenshot, and Quit. See page 15 for an explanation of these options.

B. Track Design Categories – Click on any category to open a window that contains all of the track designs in that category (those that came with the game as well as any you have added). That window is identical to the window you see when building a ride, and includes an image of each named ride, along with specifications. Click on a ride to Rename or Delete it.

C. Install New Track Design – Click here to import a saved track design. This will open a **Load File** window, where you can browse folders for saved “.TD6” track design files. Click on a file name to preview it and click OK to install it into the game. The game will automatically place it in the proper category.



DESIGNING A SCENARIO

Tips on Using the Scenario Editor

The Scenario Editor is a powerful tool that lets you create countless cool game variations that you can share with others. Creating a playable scenario takes time and patience, but stick with it and you'll soon be designing fun and thought-provoking challenges.

Because of all the intricacies of the editor, we recommend that you do not attempt to use the scenario until you are very familiar with playing the game itself. Even then, you should be prepared to make some mistakes on your first few attempts.

Think Small. On your first few scenarios, make a tiny park with just a gate, a path and a little purchased land. Save and play it to see if it works. This way you can expose some of the challenges without spending hours on a large park that may not function.

Think Simple. The fun of playing the scenarios is in the users' ability to create. If you've done all of the thinking for the player, he or she may find it less than challenging.

Create the Entrance Path First. This is the first place guests will arrive and your player will seek out. Keep in mind:

- The path from the Entrance must connect to the edge of the map.
- The paths in front and back of the gate must be connected. Place the gate and then put the paths down on both sides.
- You must mark the spot where the guests will appear on the path that leads to the front of the park Entrance.

Establish Player-Owned Land Next. Sometimes, if you go full-steam ahead, retrofitting the basic elements may not synch up with your designs. Keep in mind:

- The path from “off” the map to the Park Entrance should not be owned or purchasable by the player. The game will automatically set the route to be non-purchasable if you forget to do this.
- The land owned by the player is a single continuous piece of land. The best shapes are a circle or a rectangle.
- If the player cannot buy land in the park, they should have construction rights or the ability to purchase those rights so the separate areas can connect.
- A U-shaped park will confuse your guests and generate a low park rating.



Don't Give It All Away! Let your players work their way through a scenario to gradually see all that the game has to offer. If you give them all the land on the biggest map with all of the rides available, they may become overwhelmed or feel there is nothing else to look forward to. A good scenario should inspire and challenge, not overwhelm the player.

Save Often. There is no “redo button,” so save your landscapes every few minutes, and especially before you undertake a big excavation project. The files are small, and you can use a numbering system (i.e. “MyPark00,” “MyPark01,” “MyPark02”) to keep your saved files organized. If you make a big mistake, just go back a few iterations and begin from there. When your scenario is done, you can delete old, defunct landscape files.

Test Your Scenario Occasionally. As you are building your landscapes, you may occasionally want to step through and complete the scenario to play test it and make sure it's fun. As you get closer to the end, you should play longer. Ultimately, when you are finished building your scenario, you should play all the way through to verify the scenario objects are reasonably achievable.

Scenario Editor Elements

You will notice the Scenario Editor has many elements similar to those found in the regular game. All of these elements have the same functionality, and in a few instances additional features.

There are six steps to building a scenario:

1. Select Objects
2. Edit Landscape
3. Invention List Setup
4. Options Selections
5. Objective Selection
6. Save Scenario



Select Objects

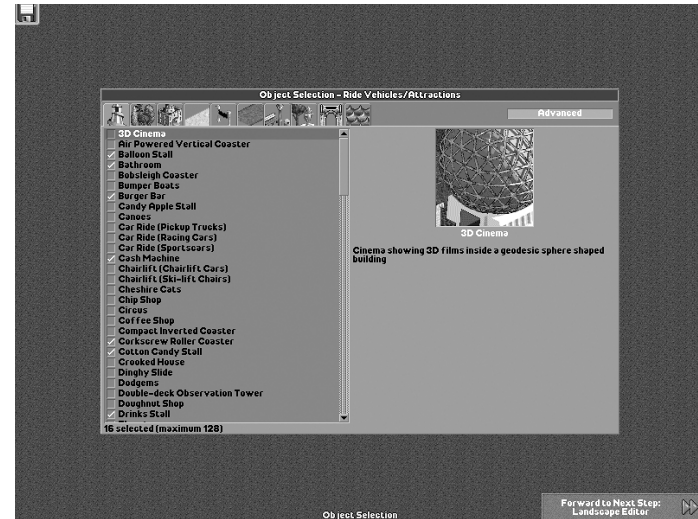

These are all the objects that will and could appear in your scenario. You can only select a limited number of objects in each category, and this number varies with object type. For example, you can select 128 ride types, but only 19 Scenery Groups, and 1 Water Texture.

The more items you use, the longer your scenario will take to load. The items with the white check mark next to them will be in your scenario. (You will decide which ones will be part of the **Research** list later.)

The **Advanced** button adds five more tabs to the selection. This lets you select individual theme elements without having to select the full theme package.



Landscape Editor

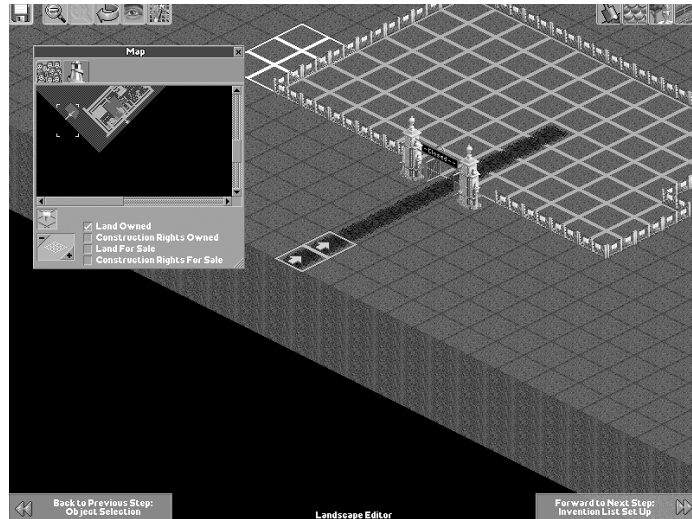

Here is where you will shape the land and create the bulk of the visuals in your scenario. You won't be placing any rides in this part of the scenario, just the scenery. (To make a scenario with an active running park filled with rides and guests, you need to use the "Convert Saved Game into a Scenario" feature located in the **Toolbox** menu off of the **Main Menu**.)

Sculpt the land as you wish. You can use the **Mini-Map** window to paint larger areas of land with different land tiles or to mark land for sale.

To move on to the next step, you minimally need the following:

- A path from the edge of the map to an Entrance gate
- A set "Guest Appearance" marker(s) on that path
- Land designated as "owned" by the player that doesn't incorporate the path or Park Entrance, but leads to it



Invention List Setup



Once you are done tinkering with the look of your scenario, you need to decide what inventions the player starts out with, and which ones they need to research to discover. Click and drag objects from the **Pre-Invented** window into the **To Invent** window.

Sort the **To Invent** list by dragging items into the sequence you want.

Alternately, you can click the **Random Shuffle** button to randomize the order in which inventions are discovered.

Options Selections

Here you decide what the parameters of your scenario are. Click the following tabs to set the options:

Financial – Establishes the amount of money players start with, as well as their initial loan, maximum loan size and interest rate. You can also forbid marketing campaigns here.

Guest – Establishes how much cash guests enter the park with on average. You can also adjust initial behaviors and characteristics, including happiness, hunger and thirst, and whether guests prefer more- or less-intense rides.





Park – Set the cost of land and construction rights, and decide whether it’s a “pay at gate” or “pay per ride” park. You can also set other conditions, such as forbidding tree removal or high construction.

Objective Selection

Each scenario needs a goal that players must reach in order to win. You should make sure it is a reasonable and fun goal to achieve. The **Objective Selection** window is where you set scenario goals, climate controls and descriptions.

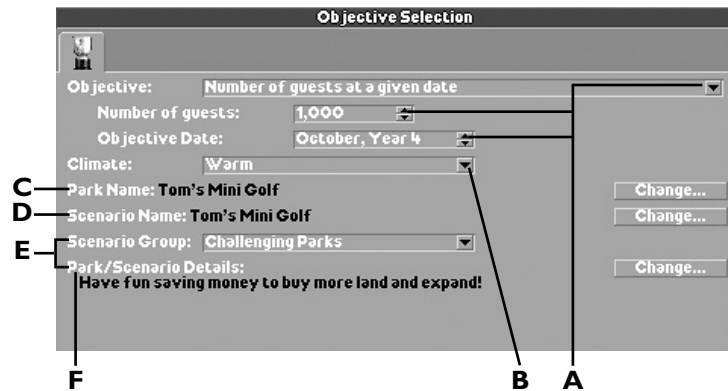

A. Objective – This drop-down menu contains a list of various scenario goals, such as number of guests or park value after a certain time period, or building roller coasters of a certain length. Depending on the goal, you need to set additional parameters, such as number and time period. These choices appear below the **Objective** menu.

B. Climate – This menu lets you choose among four climate types in which the park will be set.

C. Park Name – This is the initial name of the park. Players will be able to change it once they start the game. Click the **Change** button to enter a park name.

D. Scenario Name – This is the name that will show up in the **Scenario Selection** window. Click the **Change** button to enter a scenario name.



E. Scenario Group – Choose a category of park: Beginner, Challenging, Expert, “Real” or Other. This is the tab under which the scenario will appear in the **Scenario Selection** window.

F. Park / Scenario Details – Enter a sentence or two to give players an idea of what to expect from the scenario. Click the **Change** button to enter the message.

Save Scenario

Click the **Save Scenario** button in the lower right corner to save your scenario and return to the Main Menu. Your new scenario will appear in the **Scenario Selection** window under whatever category you assigned it.

Start the game and test it out. Keep notes for yourself on the areas you think need adjustment, then fine-tune and balance it until you’re satisfied. Email the scenario or post it online for your friends and family to play with their version of RollerCoaster Tycoon 2!

TIP

When choosing scenario parameters, you can make things more interesting by tying together the various elements. For example, you could design a “desert” scenario that has a hot and dry climate, and set it so that very thirsty guests enter the park with a lot of money. You could then set it so that players must research drink stands and water rides before they are available.

Convert Saved Game to Scenario

Use this utility, found in the **Tools** menu in the **Main Menu**, to create scenarios from saved games. This is the only way you can make a scenario that includes pre-built rides, existing population, and other components that you can only alter by playing an actual game.

Click on **Convert Saved Game to Scenario** in the **Tools** menu and then choose a saved game from the list that opens. This opens the park in the background — you can look at it, but you cannot edit it. What you can do is set goals in the **Objective Selection** window. (See page 62 for details.)

If you click the **Preserved Rides** button, you are given a list of all of the rides in the park. Click on a ride name to put a checkmark next to it. Rides designated as Preserved Rides cannot be torn down or edited by the person playing your scenario.

Click the **Save Scenario** button in the lower right corner to save your scenario and return to the **Main Menu**. Your new scenario will appear in the **Scenario Selection** window under whatever category you assigned it.



INFOGRAMES WEB SITES

To get the most out of your new game, visit us at:

<http://www.rollercoasterycoon2.com>
www.us.infogrames.com

To send e-cards to your friends, download wallpapers, or get access to other free stuff, visit our Freebies section at:

www.us.infogrames.com/freebies

If you would like to chat with other gamers, as well as developers, visit our Community Forum area at:

www.ina-community.com

Kids, check with your parent or guardian before visiting any web site.

Chat Messages: Infogrames does not monitor, control, endorse, or accept responsibility for the content of chat messages. You are strongly encouraged not to give out identity or other personal information through chat message transmissions. Kids, check with your parent or guardian if you are concerned about any chat you receive.

Use of Infogrames web sites is subject to terms and conditions, which you can access at:

www.us.infogrames.com/terms_of_service.asp

TECHNICAL SUPPORT (U.S. & CANADA)

Help Via the Internet

Up-to-the-minute technical information about Infogrames Interactive products is generally available 24 hours a day, 7 days a week via the Internet at:

<http://www.ina-support.com>

Through this site you'll have access to our **FAQ** (Frequently Asked Questions) documents, our **FTP** (File Transfer Protocol) area where you can download patches if needed, our **Hints/Cheat Codes** if they're available, and an **E-Mail** area where you can get help and ask questions if you do not find your answers within the **FAQ**.

Note: In the event we must send you a Hint Sheet, FAQ document, patch or update disc via E-mail, we may require verifiable consent from a parent or guardian in order to protect children's privacy and safety online. Consent Forms are available at the web site listed above.



Help Via Telephone/Fax or Mail in the United States & Canada

For phone assistance, call Infogrames Interactive **Tech Support** at **(425) 951-7108**. Our **Interactive Voice Response** and **Faxback** system is generally available 24/7, providing automated support and allowing FAQ documents to be faxed to you immediately.

Great News! We've improved our Automated Systems so that you can get product-specific Troubleshooting help more quickly. All you need to do is enter the product's **Part #** when prompted to do so. This will take you directly to all of our known issues and solutions for this title. The product's **Part #** is located in several places (on the CD label, package and/or plastic disc case) and is usually identified by a number such as **04-12345**. When prompted by the Automated System, enter the **last five digits** of your product's Part #. (For example, Part # 04-12345 would require that you enter the "12345" portion of the number for that product.) **Note:** Some products simply feature a five-digit Part # without an "04-" prefix.

Live support is generally available Monday through Friday, 8:00 AM until 6:00 PM (Pacific Time). **Note:** We may be closed on major holidays.

Before making your call, we ask that you be at your computer, have the following information available, and be ready to take notes:

- System Make and Model
- Processor Type
- Operating System, including version number if possible (such as Windows® 98; Windows® Me)
- RAM (Memory)
- Video and sound card data and drivers

Any screen or error messages you've encountered (and where)

You may also fax in your Technical Support questions or problems to:

(425) 806-0480, or write to the address below.



Product Return Procedures in the United States & Canada

In the event our technicians at (425) 951-7108 determine that you need to forward materials directly to us, please include a brief letter explaining what is enclosed and why. Make sure you include the Return Merchandise Authorization Number (RMA#) supplied to you by the technician, and your telephone number in case we need to call you. Any materials not containing this RMA# will be returned to you unprocessed. Send your materials to the following address:

Infogrames Interactive, Inc.
 Attn: TS/CS Dept.
 13110 NE 177th Place
 Suite # B101, Box 180
 Woodinville, WA 98072-9965
 RMA #:

Strategy Guide Available:

There is an Official Strategy Guide available for this game. Please refer to our Strategy Guide Availability List at www.ina-support.com, or find out how to place an order by telephone or mail after selecting the product RollerCoaster Tycoon 2 from the automated phone system menu at (425) 951-7108.



LICENSE AGREEMENT

*** IMPORTANT ***

This is a legal agreement between the end user ("You") and Infogrames Interactive, Inc., its parent, affiliates and subsidiaries (collectively "Infogrames Interactive"). This Agreement is part of a package (the "Package") that also includes, as applicable, executable files that you may download, a game cartridge or disc, or a CD-ROM (collectively referred to herein as the "Software") and certain written materials (the "Documentation"). Any patch, update, upgrade, modification or other enhancement provided by Infogrames Interactive with respect to the Software or the Documentation, or bonus game provided by Infogrames Interactive at no extra charge as part of the Package, shall be included within the meanings of those terms, for the purposes of this Agreement, except to the extent expressly provided below.

BY DOWNLOADING OR INSTALLING THE SOFTWARE, YOU ACKNOWLEDGE THAT YOU HAVE READ ALL OF THE TERMS AND CONDITIONS OF THIS AGREEMENT, UNDERSTAND THEM, AND AGREE TO BE BOUND BY THEM. YOU UNDERSTAND THAT, IF YOU PURCHASED THE PACKAGE FROM AN AUTHORIZED RESELLER OF INFOGRAMES INTERACTIVE, THAT RESELLER IS NOT INFOGRAMES INTERACTIVE'S AGENT AND IS NOT AUTHORIZED TO MAKE ANY REPRESENTATIONS, CONDITIONS OR WARRANTIES, STATUTORY OR OTHERWISE, ON INFOGRAMES INTERACTIVE'S BEHALF NOR TO VARY ANY OF THE TERMS OR CONDITIONS OF THIS AGREEMENT.

If You do not agree to the terms of this Agreement, do not download or install the Software and promptly return the entire Package to the place You obtained it for a full refund. If you should have any difficulty in obtaining such refund, please contact Infogrames Interactive Technical Support at 425-951-7108. Failure to return the entire Package within 30 days of the purchase date shall be presumed to constitute acceptance of the terms and conditions of this Agreement.

CONSUMER SAFETY WARNINGS AND PRECAUTIONS STATEMENT:

Epilepsy Warning



READ THIS NOTICE BEFORE YOU OR YOUR CHILD USE THIS SOFTWARE

A very small portion of the population have a condition which may cause them to experience epileptic seizures or have momentary loss of consciousness when viewing certain kinds of flashing lights or patterns. These persons may experience seizures while watching some kinds of television pictures or playing certain video games. Certain conditions may induce previously undetected epileptic symptoms even in persons who have no history of prior seizures or epilepsy.

If you or anyone in your family has an epileptic condition or has experienced symptoms like an epileptic condition (e.g. a seizure or loss of awareness), immediately consult your physician before using this Software.

We recommend that parents observe their children while they play games. If you or your child experience any of the following symptoms: dizziness, altered vision, eye or muscle twitching, involuntary movements, loss of awareness, disorientation, or convulsions, DISCONTINUE USE IMMEDIATELY and consult your physician.

FOLLOW THESE PRECAUTIONS WHENEVER USING THIS SOFTWARE:

- Do not sit or stand too close to the monitor. Play as far back from the monitor as possible.
- Do not play if you are tired or need sleep.
- Always play in a well-lit room.
- Be sure to take a 10- to 15-minute break every hour while playing.



Repetitive Strain Statement



Some people may experience fatigue or discomfort after playing for a long time. Regardless of how you feel, you should ALWAYS take a 10- to 15-minute break every hour while playing. If your hands or arms become tired or uncomfortable while playing, stop and rest. If you continue to experience soreness or discomfort during or after play, listen to the signals your body is giving you. Stop playing and consult a doctor. Failure to do so could result in long term injury.

If your hands, wrist or arms have been injured or strained in other activities, use of this Software could aggravate the condition. Before playing, consult a doctor.

Motion Sickness Statement



This Software generates realistic images and 3-D simulations. While playing or watching certain video images, some people may experience dizziness, motion sickness or nausea. If you or your child experience any of these symptoms, discontinue use and play again later.

LIMITED LICENSE: You are entitled to download or install, and operate this Software solely for your own personal use, but may not sell or transfer reproductions of the Software or Documentation to other parties in any way. You may download or install, and operate one copy of the Software on a single terminal connected to a single computer. You may not network the Software or otherwise use it on more than one computer or computer terminal at the same time.

INTERNET-BASED PLAY: CHAT: This Software may include Internet-play features. If You choose to use such features, You will need to access the Internet. The Software or Documentation may also suggest links to certain Software-related web sites, including web sites operated by Infogrames Interactive or third parties. Your access to web sites operated by Infogrames Interactive is subject to the terms of use and privacy policies of such web sites. Children should check with a parent or guardian before accessing the Internet, including without limitation any chat function, on-line "arcade," or em@il Game. Internet game play may occur through one or more independent gaming or other web sites (each a "Web Site"), including without limitation the MSN Gaming Zone run by the Microsoft Corporation. Infogrames Interactive does not review or control, and disclaims any responsibility or liability for, the functioning and performance of any Web Site, the terms of use of any Web Site, the privacy policies of any Web Site, and any content on or available via a Web Site, including, without limitation, links to other web sites and comments or other contact between users of a Web Site. Infogrames Interactive does not endorse the Web Sites merely because a link to the Web Site is suggested or established. Infogrames Interactive does not monitor, control, endorse, or accept responsibility for the content of text or voice chat messages, if applicable, transmitted through the use of the Software. Use of the chat function, or other content or services of any Web Site is at Your own risk. You are strongly encouraged not to give out identity or other personal information through chat transmissions.

OWNERSHIP: COPYRIGHT: Title to the Software and the Documentation, and patents, copyrights and all other property rights applicable thereto, shall at all times remain solely and exclusively with Infogrames Interactive and its licensors, and You shall not take any action inconsistent with such title. The Software and the Documentation are protected by United States, Canadian and other applicable laws and by international treaty provisions. Any rights not expressly granted herein are reserved to Infogrames Interactive and its licensors.

OTHER RESTRICTIONS: You may not cause or permit the disclosure, copying, renting, licensing, sublicensing, leasing, dissemination or other distribution of the Software or the Documentation by any means or in any form, without the prior written consent of Infogrames Interactive. You may not modify, enhance, supplement, create derivative work from, adapt, translate, reverse engineer, decompile, disassemble or otherwise reduce the Software to human readable form.



LIMITED WARRANTY

Infogrames Interactive warrants for a period of ninety (90) days following original retail purchase of this copy of the Software that the Software is free from substantial errors or defects that will materially interfere with the operation of the Software as described in the Documentation. This limited warranty: (i) applies to the initial purchaser only and may be acted upon only by the initial purchaser; and (ii) does not apply to any patch, update, upgrade, modification, or other enhancement provided by Infogrames Interactive with respect to the Software or the Documentation or to any bonus game provided by Infogrames Interactive at no extra charge as part of the Package, which are provided on an AS IS BASIS ONLY. EXCEPT AS STATED ABOVE, INFOGRAMS INTERACTIVE AND ITS LICENSORS MAKE NO OTHER WARRANTY OR CONDITION, EXPRESS OR IMPLIED, STATUTORY OR OTHERWISE, REGARDING THIS SOFTWARE. THE IMPLIED WARRANTY THAT THE SOFTWARE IS FIT FOR A PARTICULAR PURPOSE AND THE IMPLIED WARRANTY OF MERCHANTABILITY SHALL BOTH BE LIMITED TO THE NINETY (90) DAY DURATION OF THIS LIMITED EXPRESS WARRANTY. THESE AND ANY OTHER IMPLIED WARRANTIES OR CONDITIONS, STATUTORY OR OTHERWISE, ARE OTHERWISE EXPRESSLY AND SPECIFICALLY DISCLAIMED. Some jurisdictions do not allow limitations on how long an implied warranty or condition lasts, so the above limitation may not apply to You. This limited warranty gives You specific legal rights, and you may also have other rights which vary from jurisdiction to jurisdiction.

If you believe you have found any such error or defect in the Software during the warranty period, call Infogrames Interactive Technical Support at 425-951-7108 between the hours of 8:00 a.m. and 6:00 p.m. Monday through Friday (Pacific Time), holidays excluded, and provide your Product number. If a return is determined as necessary, a Return Merchandise Authorization Number (RMA#) will be issued to you. Send your original CD-ROM disc, game cartridge or disc, or, if applicable, the executable files that you downloaded, along with the RMA#, a dated proof of purchase, your full name, address and phone number, to Infogrames Interactive, Inc., Attn: TS/CS Dept., 13110 NE 177th Place, Suite # B101, Box 180, Woodinville, WA 98072-9965.

If you have a problem resulting from a manufacturing defect in the Software, Infogrames Interactive's and its licensors' entire liability and Your exclusive remedy for breach of this limited warranty shall be the replacement of the Software, within a reasonable period of time and without charge, with a corrected version of the Software. Some jurisdictions do not allow the exclusion or limitation of relief, incidental or consequential damages, so the above limitation or exclusion may not apply to You.

LIMITATION OF LIABILITY

INFOGRAMS INTERACTIVE AND ITS LICENSORS SHALL NOT BE LIABLE FOR SPECIAL, INCIDENTAL, CONSEQUENTIAL, EXEMPLARY OR OTHER INDIRECT DAMAGES, EVEN IF INFOGRAMS INTERACTIVE OR ITS LICENSORS ARE ADVISED OF OR AWARE OF THE POSSIBILITY OF SUCH DAMAGES. IN NO EVENT SHALL INFOGRAMS INTERACTIVE'S AND ITS LICENSORS' AGGREGATE LIABILITY EXCEED THE PURCHASE PRICE OF THIS PACKAGE. Some jurisdictions do not allow the exclusion or limitation of special, incidental, consequential, indirect or exemplary damages, or the limitation of liability to specified amounts, so the above limitation or exclusion may not apply to You.

GENERAL: This Agreement constitutes the entire understanding between Infogrames Interactive and You with respect to subject matter hereof. Any change to this Agreement must be in writing, signed by Infogrames Interactive and You. Terms and conditions as set forth in any purchase order which differ from, conflict with, or are not included in this Agreement, shall not become part of this Agreement unless specifically accepted by Infogrames Interactive in writing. You shall be responsible for and shall pay, and shall reimburse Infogrames Interactive on request if Infogrames Interactive is required to pay, any sales, use, value added (VAT), consumption or other tax (excluding any tax that is based on Infogrames Interactive's net income), assessment, duty, tariff, or other fee or charge of any kind or nature that is levied or imposed by any governmental authority on the Package.

EXPORT AND IMPORT COMPLIANCE: In the event You export the Software or the Documentation from the country in which You first received it, You assume the responsibility for compliance with all applicable export and re-export regulations, as the case may be.



GOVERNING LAW; ARBITRATION: This Agreement shall be governed by, and any arbitration hereunder shall apply, the laws of the State of New York, U.S.A., excluding (a) its conflicts of laws principles; (b) the United Nations Convention on Contracts for the International Sale of Goods; (c) the 1974 Convention on the Limitation Period in the International Sale of Goods (the "1974 Convention"); and (d) the Protocol amending the 1974 Convention, done at Vienna April 11, 1980.

Any dispute, controversy or claim arising out of or relating to this Agreement or to a breach hereof, including its interpretation, performance or termination, shall be finally resolved by arbitration. The arbitration shall be conducted by three (3) arbitrators, one to be appointed by Infogrames Interactive, one to be appointed by You and a third being nominated by the two arbitrators so selected or, if they cannot agree on a third arbitrator, by the President of the American Arbitration Association ("AAA"). The arbitration shall be conducted in English and in accordance with the commercial arbitration rules of the AAA. The arbitration, including the rendering of the award, shall take place in New York, New York, and shall be the exclusive forum for resolving such dispute, controversy or claim. The decision of the arbitrators shall be binding upon the parties hereto, and the expense of the arbitration (including without limitation the award of attorneys' fees to the prevailing party) shall be paid as the arbitrators determine. The decision of the arbitrators shall be executory, and judgment thereon may be entered by any court of competent jurisdiction.

Notwithstanding anything contained in the foregoing Paragraph to the contrary, Infogrames Interactive shall have the right to institute judicial proceedings against You or anyone acting by, through or under You, in order to enforce Infogrames Interactive's rights hereunder through reformation of contract, specific performance, injunction or similar equitable relief. For the purposes of this Paragraph, both parties submit to the jurisdiction of, and waive any objection to the venue of, the state and federal courts of the State of New York.



CREDITS

Chris Sawyer
Design and Programming

Simon Foster
Graphics

Allister Brimble
Sound and Music

Additional sounds recorded by
David Ellis
Representation by Jacqui Lyons
at Marjacq Ltd.

Thanks to
Peter James Adcock
Joe Booth
John Wardley

Infogrames Interactive, Inc.

Tom Zahorik
Senior Producer

Scott Triola
Brand Manager

Bill Levay
Executive Producer

Scott Walker
V.P. of Product Development

Ann Marie Bland
Director of Marketing

Steve Martin
Director of Creative Services

Elizabeth Mackney
Director of Editorial &
Documentation Services

Charles Rizzo
Art Director

Paul Anselmi
Graphic Designer

Kurt Carlson
Documentation Specialist

Paul Collin
Copywriter

Special Thanks
Peter Matiss

Infogrames Q.A.

Michael Craighead
Director of Quality Assurance,
North America

Kurt Boutin
Senior Manager, Q.A. Certification Group

Ken Edwards
Engineering Specialist

Luis Rivas
Engineerring Services Manager

Randy Lee
Bill Carroll

Q.A. Testing Managers

Mark Huggins
Q.A. Certification Lead

Matt Pantaleoni
Senior Tester

Daniel Frisoli
Lead Tester

Dena Irene Fitzgerald
Scott Rollins

Christopher McPhail
Clif McClure

Erik Maramaldi
Erik Jeffery

Testers
Geoffrey Smith

Lead Computability Analyst

Jason Cordero
Burke McQuinn

Kim Jardin
Computability Analysts

Music acknowledgements

Searchlight Rag © Scott Joplin
Flight of Fantasy © Steve

Blenkinsopp.

Original recordings © C.J.
Mears Organisation — used
with consent.

Samples courtesy of
Spectronics Liquid Grooves.

© 2002 Infogrames Interactive, Inc. All Rights Reserved.
Manufactured and marketed by Infogrames, Inc., New York, NY.
All trademarks are the property of their respective owners.

© 2002 Chris Sawyer. All Rights Reserved.

SIX FLAGS and all related indicia are trademarks of Six Flags Theme Parks Inc. ®, TM and © 2002.

Windows and DirectX are either registered trademarks or
trademarks of Microsoft Corporation in the United States and/or other countries.

Pentium is a trademark or registered trademark of Intel Corporation or
its subsidiaries in the United States and other countries.

08232

**RCT2PC
MANUAL BACK COVER**